



*Quality Parts*

**GRUPPO  
RUGGERINI MC-RF**

**17**

**RUGGERINI MC-RF  
FAMILY**

**RICAMBI ALTERNATIVI PER MOTORI**

**INTERMOTOR, LOMBARDINI Benzina,  
SLANZI, ACME, RUGGERINI**

**NON ORIGINAL PARTS FOR**

**INTERMOTOR, LOMBARDINI Petrol,  
SLANZI, ACME, RUGGERINI ENGINES**

**REL 811**

Questo catalogo contiene dati ed informazioni provenienti dalla pluriennale esperienza di Finimpianti. Tuttavia non possiamo assumere alcuna responsabilità per eventuali dati errati od incompleti.

Tutti i dati e le informazioni contenute nel presente catalogo sono fornite a puro scopo informativo e senza responsabilità e non potranno dare adito ad alcuna forma di risarcimento.

Visto il continuo sviluppo dei nostri prodotti, Finimpianti si riserva il diritto di apportare modifiche senza preavviso.

Denominazioni, numeri e codici originali sono riportati a puro titolo di riferimento.

*All the information and data contained in this catalogue came from the long Finimpianti experience. Nevertheless we can not assume any responsibility for possible mistakes.*

*All the information and data contained in this catalogue are provide "as is" without any representation or warranty express or implied. Under no circumstances whatsoever shall Finimpianti be liable for any damages whatsoever arising out of the use of the information and data contained in this catalogue.*

*Finimpianti does not warrant the accuracy or completeness of the materials and content contained in this catalogue and reserves the right to correct any errors or omissions at any time without notice and without obligation to the users of this catalogue.*

*OEM names, codes and part numbers, used in this catalogue, are for reference only.*

**GRUPPO MC – RF**  
**RUGGERINI**  
***FAMILY MC – RF***

1	MC 70
3	MC 71
5	RF 80
7	RF 81
9	RF 88
11	RF 90
13	RF 91
15	RF 100
17	RF 120
19	RF 121
21	RF 130
23	RF 140
25	RF 148
27	ALTRI ARTICOLI <i>OTHERS ITEMS</i>

Questo catalogo contiene dati ed informazioni provenienti dalla pluriennale esperienza di Finimpianti. Tuttavia non possiamo assumere alcuna responsabilità per eventuali dati errati od incompleti.

Tutti i dati e le informazioni contenute nel presente catalogo sono fornite a puro scopo informativo e senza responsabilità e non potranno dare adito ad alcuna forma di risarcimento.

Visto il continuo sviluppo dei nostri prodotti, Finimpianti si riserva il diritto di apportare modifiche senza preavviso.

Denominazioni, numeri e codici originali sono riportati a puro titolo di riferimento.

*All the information and data contained in this catalogue came from the long Finimpianti experience. Nevertheless we can not assume any responsibility for possible mistakes.*



*All the information and data contained in this catalogue are provide "as is" without any representation or warranty express or implied. Under no circumstances whatsoever shall Finimpianti be liable for any damages whatsoever arising out of the use of the information and data contained in this catalogue.*







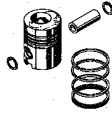
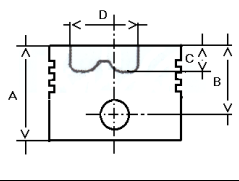

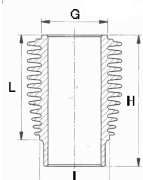
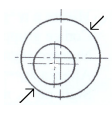
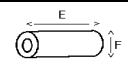
*Finimpianti does not warrant the accuracy or completeness of the materials and content contained in this catalogue and reserves the right to correct any errors or omissions at any time without notice and without obligation to the users of this catalogue.*

*OEM names, codes and part numbers, used in this catalogue, are for reference only.*

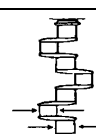
# RUGGERINI

<b>MC 70</b>	<b>Cm<sup>3</sup></b>	<b>CILINDRI CYLINDERS</b>	<b>ALESAGGIO BORE</b>	<b>CORSA STROKE</b>	<b>VERSIONE VERSION</b>
	377	1	80	75	

		<b>TESTA HEAD</b>	<b>H08</b>		3	2,5	<b>TIPO TYPE</b>	<b>A</b>			
					10	2,5					
					23	4					
										G	105
										H	133,90
										I	98
		A	75	2340	FIN067RS00	203.19	FIN025SL00				
		B	40								
		C	12								
		D	40,5								
	FIN200PN 854.12	E	67,5	2341	FIN067RS05						
		F	22	2342	FIN067RS10						
		80	A2077	FIN190PC00							
		80,5	A2078	FIN190PC05							
		81	A2079	FIN190PC10							

		<b>Nr.</b>						ADATTABILE A: SUITABLE FOR:	
---	---	------------	---	---	---	---	---	--------------------------------	---

CR	AL	1	40,05	43,66	24,38		STD - 025 - 050 - 075 - 100	A2639	FIN043CR STD
----	----	---	-------	-------	-------	--	-----------------------------	-------	--------------

MB	ALL	2	42,09	50,03	40,20		STD - 025 - 050 - 075 - 100 - BAR - BAR EM1	310.16	FIN016MB STD
----	-----	---	-------	-------	-------	--	---	--------	--------------





--	--	--	--	--	--	--	--	--	--



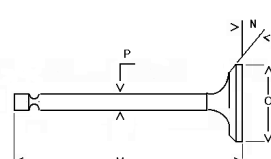

--	--	--	--	--	--	--	--	--	--

--	--	--	--	--	--	--	--	--	--

--	--	--	--	--	--	--	--	--	--

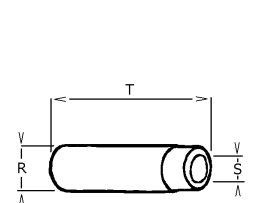
--	--	--	--	--	--	--	--	--	--

	<b>IN EX</b>		<b>Nr.</b>	<b>O</b>	<b>P</b>	<b>M</b>	<b>N</b>		ADATTABILE A: SUITABLE FOR:								
	IN								FS	1	33	7	95	45	A1	960.49	FINA027
	EX								FN	1	30	7	95	45	A1	960.50	FINS028

	<b>IN EX</b>		<b>Nr.</b>	<b>R</b>	<b>S</b>	<b>T</b>		ADATTABILE A: SUITABLE FOR:							
	IN							G	1	13,05	7,03	39	I	464.77	FIN208ASA
	IN							G		13,15	7,03	39	I	464.59	FIN208ASB
	EX							G	1	13,05	7,03	39	I	464.77	FIN208ASA
	EX							G		13,15	7,03	39	I	464.59	FIN208ASB

Ricambi non originali per motori. Denominazioni e codici originali, sono riportati a puro titolo di riferimento.

# RUGGERINI

<b>MC 70</b>	<b>Cm<sup>3</sup></b>	<b>CILINDRI CYLINDERS</b>	<b>ALESAGGIO BORE</b>	<b>CORSA STROKE</b>	<b>VERSIONE VERSION</b>
	377	1	80	75	

	2329	2856			447.76	447.79	448.14	448.14
FIN105CGA	FIN105CGB	FIN079SM	FIN3216RT	FIN3215RT	FIN206CO	FIN281CB	FIN503IG	FIN503IG

 	ADATTABILE A: SUITABLE FOR:		<b>Nr.</b>	<b>ENGINE KIT</b>	<b>ELECTRIC KIT</b> 
	449.83	FIN6240HG	1	 FIN025SL00	
			1	 FIN190PC00	
			1	 FIN079SM	
			A2391	FIN0850KIT	

388.36	060.06	359.30		175.32	175.05		
FIN2210AF	FIN5012PF	FIN1030NF		FIN020FE	FIN4225OF		

100.36	2912			2122			
FIN1060KR	FIN080CK			FIN022OP			

	656.41	644.51	644.52	660.20	956.51		
	FIN701JP	FIN503NH	FIN051NO	FIN059E	FIN098DV		

696.78							
FIN038PU	FIN003CN						

			527.44				
			FIN112SI				

Ricambi non originali per motori. Denominazioni e codici originali, sono riportati a puro titolo di riferimento.



2 - 17







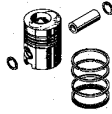
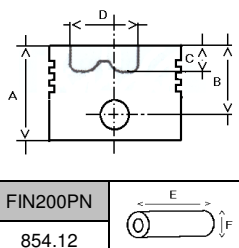

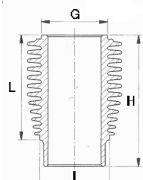
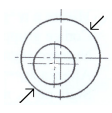
rel. 609

Non original engine parts. OEMs names and part numbers are for reference purpose only.

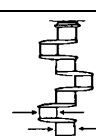
# RUGGERINI

<b>MC 71</b>	<b>Cm<sup>3</sup></b>	<b>CILINDRI CYLINDERS</b>	<b>ALESAGGIO BORE</b>	<b>CORSA STROKE</b>	<b>VERSIONE VERSION</b>
	377	1	80	75	

		<b>TESTA HEAD</b>	H08		3	2,5	<b>TIPO TYPE</b>	A		
		A	75		10	2,5			G	105
		B	40		23	4			H	133,90
		C	12						I	98
		D	40,5						L	79,90
		E	67,5							
FIN200PN	854.12									
	80	A2077	FIN190PC00	2340	FIN067RS00		203.19		FIN025SL00	
	80,5	A2078	FIN190PC05	2341	FIN067RS05					
	81	A2079	FIN190PC10	2342	FIN067RS10					

		<b>Nr.</b>						ADATTABILE A: SUITABLE FOR:	
---	---	------------	---	---	---	---	---	--------------------------------	---

CR	AL	1	40,05	43,66	24,38		STD - 025 - 050 - 075 - 100	A2639	FIN043CR STD
----	----	---	-------	-------	-------	--	-----------------------------	-------	--------------

MB	ALL	2	42,09	50,03	40,20		STD - 025 - 050 - 075 - 100 - BAR - BAR EM1	310.16	FIN016MB STD
----	-----	---	-------	-------	-------	--	---	--------	--------------





--	--	--	--	--	--	--	--	--	--



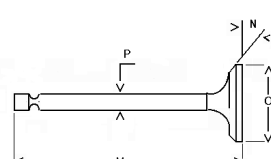

--	--	--	--	--	--	--	--	--	--

--	--	--	--	--	--	--	--	--	--

--	--	--	--	--	--	--	--	--	--

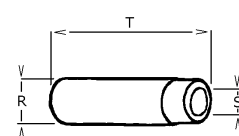
--	--	--	--	--	--	--	--	--	--

	<b>IN EX</b>		<b>Nr.</b>	<b>O</b>	<b>P</b>	<b>M</b>	<b>N</b>		ADATTABILE A: SUITABLE FOR:			
	IN		FS	1	33	7	95		45	A1	960.49	FINA027
	EX		FN	1	30	7	95		45	A1	960.50	FINS028

	<b>IN EX</b>		<b>Nr.</b>	<b>R</b>	<b>S</b>	<b>T</b>		ADATTABILE A: SUITABLE FOR:			
	IN		G	1	13,05	7,03		39	I	464.77	FIN208ASA
	IN		G		13,15	7,03		39	I	464.59	FIN208ASB
	EX		G	1	13,05	7,03		39	I	464.77	FIN208ASA
	EX		G		13,15	7,03		39	I	464.59	FIN208ASB

Ricambi non originali per motori. Denominazioni e codici originali, sono riportati a puro titolo di riferimento.

# RUGGERINI

<b>MC 71</b>	<b>Cm<sup>3</sup></b>	<b>CILINDRI CYLINDERS</b>	<b>ALESAGGIO BORE</b>	<b>CORSA STROKE</b>	<b>VERSIONE VERSION</b>
	377	1	80	75	

	2329	2856			447.76	447.79	448.14	448.14
FIN105CGA	FIN105CGB	FIN079SM	FIN3216RT	FIN3215RT	FIN206CO	FIN281CB	FIN503IG	FIN503IG

 	ADATTABILE A: SUITABLE FOR:		<b>Nr.</b>	<b>ENGINE KIT</b>	<b>ELECTRIC KIT</b> 
	449.83	FIN6240HG	1	 FIN025SL00	
			1	 FIN190PC00	
			1	 FIN079SM	
			A2391	FIN0850KIT	

388.36	060.06	359.30		175.32	175.05		
FIN2210AF	FIN5012PF	FIN1030NF		FIN020FE	FIN4225OF		

100.36	2912			2122			
FIN1060KR	FIN080CK			FIN022OP			

	656.41	644.51	644.52	660.20	956.51		
	FIN701JP	FIN503NH	FIN051NO	FIN059E	FIN098DV		

696.78							
FIN038PU	FIN003CN						

			527.44				
			FIN112SI				

Ricambi non originali per motori. Denominazioni e codici originali, sono riportati a puro titolo di riferimento.



# RUGGERINI

<b>RF 80</b>	<b>Cm<sup>3</sup></b>	<b>CILINDRI CYLINDERS</b>	<b>ALESAGGIO BORE</b>	<b>CORSA STROKE</b>	<b>VERSIONE VERSION</b>
	377	1	80	75	

		<b>TESTA HEAD</b>	<b>H08</b>			<b>TIPO TYPE</b>	<b>A</b>	
		A	75				G	105
		B	40				H	133,90
		C	12				I	98
		D	40,5				L	79,90
		E	67,5				<b>203.19</b>	
<b>FIN200PN</b> 								
854.12								
80	A2077	<b>FIN190PC00</b>		2340	<b>FIN067RS00</b>			
80,5	A2078	<b>FIN190PC05</b>		2341	<b>FIN067RS05</b>			
81	A2079	<b>FIN190PC10</b>		2342	<b>FIN067RS10</b>			

		<b>Nr.</b>							ADATTABILE A: SUITABLE FOR:	
--	--	------------	--	--	--	--	--	--	--------------------------------	--

CR	AL	1	40,05	43,66	24,38		STD - 025 - 050 - 075 - 100	A2639	FIN043CR STD
----	----	---	-------	-------	-------	--	-----------------------------	-------	--------------

MB	RP	2	42,09	50,03	26,00		STD - 025 - 050	311.01	FIN001MB STD
----	----	---	-------	-------	-------	--	-----------------	--------	--------------

MB	ALL	2	42,09	50,03	40,20		STD - 025 - 050 - 075 - 100 - BAR - BAR EM1	310.16	FIN016MB STD
----	-----	---	-------	-------	-------	--	---	--------	--------------

<div style="border: 1px solid black; padding: 5px; display: inline-block;">                 SOLUZIONE ALTERNATIVA  <b>FIN016MB = FIN001MB + FIN002TW</b>                  ALTERNATIVE SOLUTION             </div>									

TW	AL	1	50,00	63,00	3,00		STD	060.39	FIN002TW STD
----	----	---	-------	-------	------	--	-----	--------	--------------

--	--	--	--	--	--	--	--	--	--

	<b>IN EX</b>		<b>Nr.</b>	<b>O</b>	<b>P</b>	<b>M</b>	<b>N</b>		ADATTABILE A: SUITABLE FOR:	
	IN	FS	1	33	7	95	45	A1	960.49	FINA027
	EX	FN	1	30	7	95	45	A1	960.50	FINS028

	<b>IN EX</b>		<b>Nr.</b>	<b>R</b>	<b>S</b>	<b>T</b>		ADATTABILE A: SUITABLE FOR:	
	IN	G	1	13,05	7,03	39	I	464.77	FIN208ASA
	IN	G		13,15	7,03	39	I	464.59	FIN208ASB
	EX	G	1	13,05	7,03	39	I	464.77	FIN208ASA
	EX	G		13,15	7,03	39	I	464.59	FIN208ASB

# RUGGERINI

<b>RF 80</b>	<b>Cm<sup>3</sup></b>	<b>CILINDRI CYLINDERS</b>	<b>ALESAGGIO BORE</b>	<b>CORSA STROKE</b>	<b>VERSIONE VERSION</b>
	377	1	80	75	

	2329	2856			447.76	447.79	448.14	448.14
FIN105CGA	FIN105CGB	FIN079SM	FIN3216RT	FIN3215RT	FIN206CO	FIN281CB	FIN503IG	FIN503IG

 	ADATTABILE A: SUITABLE FOR:		<b>Nr.</b>	<b>ENGINE KIT</b>	<b>ELECTRIC KIT</b> 
	449.83	FIN6240HG	1	 FIN025SL00	
			1	 FIN190PC00	
			1	 FIN079SM	
			A2391	FIN0850KIT	

388.40	060.06	359.30	060.13	175.32	175.05		894.21
FIN290AF	FIN5012PF	FIN1030NF	FIN600CFA	FIN020FE	FIN4225OF		FIN023SF

100.36	2912			A2417			
FIN1060KR	FIN080CK			FIN028OP			

	656.41	644.38	644.37	660.20	956.51		
	FIN701JP	FIN502NH	FIN051NO	FIN059E	FIN098DV		

696.32							
FIN032PU	FIN003CN						

014.09	730.13	563.50	527.44				
FIN323VA	FIN238VR	FIN142TL	FIN112SI				

Ricambi non originali per motori. Denominazioni e codici originali, sono riportati a puro titolo di riferimento.

6 - 17

rel. 609

Non original engine parts. OEMs names and part numbers are for reference purpose only.

# RUGGERINI

<b>RF 81</b>	<b>Cm<sup>3</sup></b>	<b>CILINDRI CYLINDERS</b>	<b>ALESAGGIO BORE</b>	<b>CORSA STROKE</b>	<b>VERSIONE VERSION</b>
	377	1	80	75	

		<b>TESTA HEAD</b>	<b>H08</b>			<b>TIPO TYPE</b>	<b>A</b>		
		A	75					G	105
		B	40					H	133,90
		C	12					I	98
		D	40,5					L	79,90
		E	67,5					<b>203.19</b>	
854.12		F	22	2340	FIN067RS00				
80	A2077	FIN190PC00		2341	FIN067RS05				
80,5	A2078	FIN190PC05		2342	FIN067RS10				
81	A2079	FIN190PC10							

		<b>Nr.</b>							ADATTABILE A: SUITABLE FOR:	
--	--	------------	--	--	--	--	--	--	--------------------------------	--

CR	AL	1	40,05	43,66	24,38		STD - 025 - 050 - 075 - 100	A2639	FIN043CR STD
----	----	---	-------	-------	-------	--	-----------------------------	-------	--------------

MB	RP	2	42,09	50,03	26,00		STD - 025 - 050	311.01	FIN001MB STD
----	----	---	-------	-------	-------	--	-----------------	--------	--------------

MB	ALL	2	42,09	50,03	40,20		STD - 025 - 050 - 075 - 100 - BAR - BAR EM1	310.16	FIN016MB STD
----	-----	---	-------	-------	-------	--	---	--------	--------------

--	--	--	--	--	--	--	--	--	--

--	--	--	--	--	--	--	--	--	--

TW	AL	1	50,00	63,00	3,00		STD	060.39	FIN002TW STD
----	----	---	-------	-------	------	--	-----	--------	--------------

--	--	--	--	--	--	--	--	--	--

	<b>IN EX</b>		<b>Nr.</b>	<b>O</b>	<b>P</b>	<b>M</b>	<b>N</b>		ADATTABILE A: SUITABLE FOR:	
	IN	FS	1	33	7	95	45	A1	960.49	FINA027
	EX	FN	1	30	7	95	45	A1	960.50	FINS028

	<b>IN EX</b>		<b>Nr.</b>	<b>R</b>	<b>S</b>	<b>T</b>		ADATTABILE A: SUITABLE FOR:	
	IN	G	1	13,05	7,03	39	I	464.77	FIN208ASA
	IN	G		13,15	7,03	39	I	464.59	FIN208ASB
	EX	G	1	13,05	7,03	39	I	464.77	FIN208ASA
	EX	G		13,15	7,03	39	I	464.59	FIN208ASB

Ricambi non originali per motori. Denominazioni e codici originali, sono riportati a puro titolo di riferimento.

**7 - 17**

rel. 609

Non original engine parts. OEMs names and part numbers are for reference purpose only.

# RUGGERINI

<b>RF 81</b>	<b>Cm<sup>3</sup></b>	<b>CILINDRI CYLINDERS</b>	<b>ALESAGGIO BORE</b>	<b>CORSA STROKE</b>	<b>VERSIONE VERSION</b>
	377	1	80	75	

	2329	2856			447.76	447.79	448.14	448.14
FIN105CGA	FIN105CGB	FIN079SM	FIN3216RT	FIN3215RT	FIN206CO	FIN281CB	FIN503IG	FIN503IG

 	ADATTABILE A: SUITABLE FOR:		<b>Nr.</b>	<b>ENGINE KIT</b>	<b>ELECTRIC KIT</b> 
	449.83	FIN6240HG	1	 FIN025SL00	
			1	 FIN190PC00	
			1	 FIN079SM	
			A2391	FIN0850KIT	

388.40	060.06	359.30	060.13	175.32	175.05		894.21
FIN290AF	FIN5012PF	FIN1030NF	FIN600CFA	FIN020FE	FIN4225OF		FIN023SF

100.36	2912			A2417			
FIN1060KR	FIN080CK			FIN028OP			

	656.41	644.38	644.37	660.20	956.51		
	FIN701JP	FIN502NH	FIN051NO	FIN059E	FIN098DV		



696.32							
FIN032PU	FIN003CN						







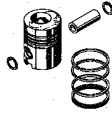
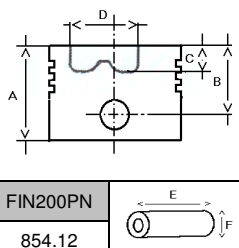

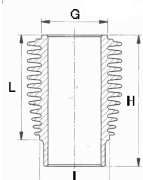
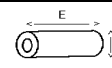
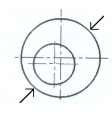
014.09	730.13	563.50	527.44				
FIN323VA	FIN238VR	FIN142TL	FIN112SI				

Ricambi non originali per motori. Denominazioni e codici originali, sono riportati a puro titolo di riferimento.

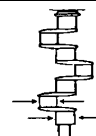
# RUGGERINI

<b>RF 88</b>	<b>Cm<sup>3</sup></b>	<b>CILINDRI CYLINDERS</b>	<b>ALESAGGIO BORE</b>	<b>CORSA STROKE</b>	<b>VERSIONE VERSION</b>
	377	1	80	75	

		<b>TESTA HEAD</b>	H08		3	2,5	<b>TIPO TYPE</b>	A		
		A	75		10	2,5			G	105
		B	40		23	4			H	133,90
		C	12						I	98
		D	40,5						L	79,90
		E	67,5							
FIN200PN		F	22							
854.12										
	80	A2077	FIN190PC00	2340	FIN067RS00		203.19	FIN025SL00		
	80,5	A2078	FIN190PC05	2341	FIN067RS05					
	81	A2079	FIN190PC10	2342	FIN067RS10					

		<b>Nr.</b>						ADATTABILE A: SUITABLE FOR:	
---	---	------------	---	---	---	---	---	--------------------------------	---

CR	AL	1	40,05	43,66	24,38		STD - 025 - 050 - 075 - 100	A2639	FIN043CR STD
----	----	---	-------	-------	-------	--	-----------------------------	-------	--------------

MB	ALL	2	42,09	50,03	40,20		STD - 025 - 050 - 075 - 100 - BAR - BAR EM1	310.16	FIN016MB STD
----	-----	---	-------	-------	-------	--	---	--------	--------------





--	--	--	--	--	--	--	--	--	--



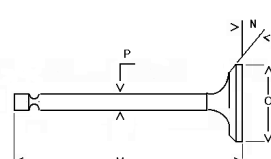

--	--	--	--	--	--	--	--	--	--

--	--	--	--	--	--	--	--	--	--

--	--	--	--	--	--	--	--	--	--

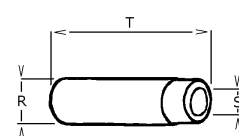
--	--	--	--	--	--	--	--	--	--

	<b>IN EX</b>		<b>Nr.</b>	<b>O</b>	<b>P</b>	<b>M</b>	<b>N</b>		ADATTABILE A: SUITABLE FOR:			
	IN		FS	1	33	7	95		45	A1	960.49	FINA027
	EX		FN	1	30	7	95		45	A1	960.50	FINS028

	<b>IN EX</b>		<b>Nr.</b>	<b>R</b>	<b>S</b>	<b>T</b>		ADATTABILE A: SUITABLE FOR:			
	IN		G	1	13,05	7,03		39	I	464.77	FIN208ASA
	IN		G		13,15	7,03		39	I	464.59	FIN208ASB
	EX		G	1	13,05	7,03		39	I	464.77	FIN208ASA
	EX		G		13,15	7,03		39	I	464.59	FIN208ASB

Ricambi non originali per motori. Denominazioni e codici originali, sono riportati a puro titolo di riferimento.

9 - 17

rel. 609

Non original engine parts. OEMs names and part numbers are for reference purpose only.

# RUGGERINI

<b>RF 88</b>	<b>Cm<sup>3</sup></b>	<b>CILINDRI CYLINDERS</b>	<b>ALESAGGIO BORE</b>	<b>CORSA STROKE</b>	<b>VERSIONE VERSION</b>
	377	1	80	75	

	2329	2856			447.76	447.79	448.14	448.14
FIN105CGA	FIN105CGB	FIN079SM	FIN3216RT	FIN3215RT	FIN206CO	FIN281CB	FIN503IG	FIN503IG

 	ADATTABILE A: SUITABLE FOR:		<b>Nr.</b>	<b>ENGINE KIT</b>	<b>ELECTRIC KIT</b> 
	449.83	FIN6240HG	1	 FIN025SL00	
			1	 FIN190PC00	
			1	 FIN079SM	
			A2391	FIN0850KIT	

388.40	060.06	359.30	060.13	175.23	175.05		
FIN290AF	FIN5012PF	FIN1030NF	FIN600CFA	FIN4231FE	FIN4225OF		

100.36	2912			2122			
FIN1060KR	FIN080CK			FIN022OP			

	656.41	644.51	644.37	660.20	956.51		
	FIN701JP	FIN503NH	FIN051NO	FIN059E	FIN098DV		

696.78							
FIN038PU	FIN003CN						

			526.66				
			FIN113SI				

Ricambi non originali per motori. Denominazioni e codici originali, sono riportati a puro titolo di riferimento.



**10 - 17**





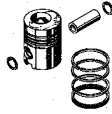
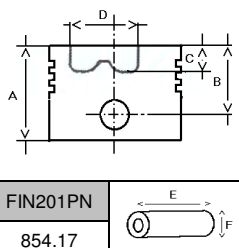

rel. 609

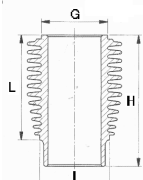
*Non original engine parts. OEMs names and part numbers are for reference purpose only.*

# RUGGERINI

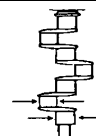
<b>RF 90</b>	<b>Cm<sup>3</sup></b>	<b>CILINDRI CYLINDERS</b>	<b>ALESAGGIO BORE</b>	<b>CORSA STROKE</b>	<b>VERSIONE VERSION</b>
	477	1	90	75	

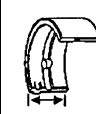
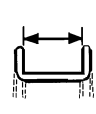
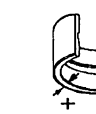
		<b>TESTA HEAD</b>	H13		<table border="1"> <tr><td>3</td><td>2</td></tr> <tr><td>10</td><td>2</td></tr> <tr><td>23</td><td>4</td></tr> </table>	3	2	10	2	23	4	<b>TIPO TYPE</b>	A	
		3	2											
10	2													
23	4													
FIN201PN	854.17	E	64		G	105								
90	A2153	FIN197PC00			A2157	FIN072RS00	H	129						
90,5	A2154	FIN197PC05		A2158	FIN072RS05	I	98							
91	A2155	FIN197PC10		A2159	FIN072RS10	L	79,90							
						203.71	FIN029SL00							

		<b>Nr.</b>						ADATTABILE A: SUITABLE FOR:	
---	---	------------	---	---	---	---	---	--------------------------------	---

CR	AL	1	40,05	43,66	24,38		STD - 025 - 050 - 075 - 100	A2639	FIN043CR STD
----	----	---	-------	-------	-------	--	-----------------------------	-------	--------------





MB	RP	2	42,09	50,03	26,00		STD - 025 - 050	311.01	FIN001MB STD
----	----	---	-------	-------	-------	--	-----------------	--------	--------------



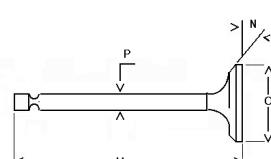

MB	ALL	2	42,09	50,03	40,20		STD - 025 - 050 - 075 - 100 - BAR - BAR EM1	310.16	FIN016MB STD
----	-----	---	-------	-------	-------	--	---	--------	--------------

--	--	--	--	--	--	--	--	--	--

TW	AL	1	50,00	63,00	3,00		STD	060.39	FIN002TW STD
----	----	---	-------	-------	------	--	-----	--------	--------------

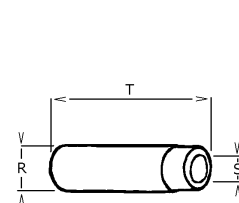
--	--	--	--	--	--	--	--	--	--

	<b>IN EX</b>		<b>Nr.</b>	<b>O</b>	<b>P</b>	<b>M</b>	<b>N</b>		ADATTABILE A: SUITABLE FOR:			
	IN		FS	1	39	7	95		45	A1	960.56	FINA160
	EX		FN	1	36	7	95		45	A1	960.55	FINS161

	<b>IN EX</b>		<b>Nr.</b>	<b>R</b>	<b>S</b>	<b>T</b>		ADATTABILE A: SUITABLE FOR:			
	IN		G	1	13,05	7,03		39	I	464.77	FIN208ASA
	IN		G		13,15	7,03		39	I	464.59	FIN208ASB
	EX		G	1	13,05	7,03		39	I	464.77	FIN208ASA
	EX		G		13,15	7,03		39	I	464.59	FIN208ASB

Ricambi non originali per motori. Denominazioni e codici originali, sono riportati a puro titolo di riferimento.

**11 - 17**

rel. 609

Non original engine parts. OEMs names and part numbers are for reference purpose only.

# RUGGERINI

<b>RF 90</b>	<b>Cm<sup>3</sup></b>	<b>CILINDRI CYLINDERS</b>	<b>ALESAGGIO BORE</b>	<b>CORSA STROKE</b>	<b>VERSIONE VERSION</b>
	477	1	90	75	

	2140	2394			447.76	447.79	448.14	448.14
FIN110CGA	FIN110CGB	FIN084SM	FIN3216RT	FIN3215RT	FIN206CO	FIN281CB	FIN503IG	FIN503IG

 ↓ === ↑	ADATTABILE A: SUITABLE FOR:		<b>Nr.</b>	<b>ENGINE KIT</b>	<b>ELECTRIC KIT</b> 
	448.08	FIN6241HG	1	 FIN029SL00	
			1	 FIN197PC00	
			1	 FIN084SM	
			A2392	FIN0910KIT	

388.29	059.90	359.26	060.48	175.32	175.05		894.21
FIN290AF	FIN090PF	FIN821NF	FIN840CFA	FIN020FE	FIN4225OF		FIN023SF

100.36	2912			A2417			
FIN1060KR	FIN080CK			FIN028OP			

	656.41	644.38	644.37	660.20	956.51		
	FIN701JP	FIN502NH	FIN051NO	FIN059E	FIN098DV		

696.78							
FIN038PU	FIN003CN						

014.09	730.13	563.50	527.44				
FIN323VA	FIN238VR	FIN142TL	FIN112SI				

Ricambi non originali per motori. Denominazioni e codici originali, sono riportati a puro titolo di riferimento.

**12 - 17**

rel. 609

*Non original engine parts. OEMs names and part numbers are for reference purpose only.*



# RUGGERINI

<b>RF 91</b>	<b>Cm<sup>3</sup></b>	<b>CILINDRI CYLINDERS</b>	<b>ALESAGGIO BORE</b>	<b>CORSA STROKE</b>	<b>VERSIONE VERSION</b>
	477	1	90	75	

		<b>TESTA HEAD</b>	H13			<b>TIPO TYPE</b>	A		
		A	80					G	105
		B	40					H	129
		C	14,7					I	98
		D	40,3					L	79,90
		E	64					203.71	
854.17	F	22							
	90	A2153	FIN197PC00	A2157	FIN072RS00				
	90,5	A2154	FIN197PC05	A2158	FIN072RS05				
	91	A2155	FIN197PC10	A2159	FIN072RS10				

		<b>Nr.</b>							ADATTABILE A: SUITABLE FOR:	
--	--	------------	--	--	--	--	--	--	--------------------------------	--

CR	AL	1	40,05	43,66	24,38		STD - 025 - 050 - 075 - 100	A2639	FIN043CR STD
----	----	---	-------	-------	-------	--	-----------------------------	-------	--------------

MB	RP	2	42,09	50,03	26,00		STD - 025 - 050	311.01	FIN001MB STD
----	----	---	-------	-------	-------	--	-----------------	--------	--------------

MB	ALL	2	42,09	50,03	40,20		STD - 025 - 050 - 075 - 100 - BAR - BAR EM1	310.16	FIN016MB STD
----	-----	---	-------	-------	-------	--	---	--------	--------------

<div style="border: 1px solid black; padding: 5px; display: inline-block;">                 SOLUZIONE ALTERNATIVA  <b>FIN016MB = FIN001MB + FIN002TW</b>                  ALTERNATIVE SOLUTION             </div>									

TW	AL	1	50,00	63,00	3,00		STD	060.39	FIN002TW STD
----	----	---	-------	-------	------	--	-----	--------	--------------

--	--	--	--	--	--	--	--	--	--

	<b>IN EX</b>		<b>Nr.</b>	<b>O</b>	<b>P</b>	<b>M</b>	<b>N</b>		ADATTABILE A: SUITABLE FOR:	
	IN	FS	1	39	7	95	45	A1	960.56	FINA160
	EX	FN	1	36	7	95	45	A1	960.55	FINS161

	<b>IN EX</b>		<b>Nr.</b>	<b>R</b>	<b>S</b>	<b>T</b>		ADATTABILE A: SUITABLE FOR:	
	IN	G	1	13,05	7,03	39	I	464.77	FIN208ASA
	IN	G		13,15	7,03	39	I	464.59	FIN208ASB
	EX	G	1	13,05	7,03	39	I	464.77	FIN208ASA
	EX	G		13,15	7,03	39	I	464.59	FIN208ASB

Ricambi non originali per motori. Denominazioni e codici originali, sono riportati a puro titolo di riferimento.

**13 - 17**

rel. 609

Non original engine parts. OEMs names and part numbers are for reference purpose only.

# RUGGERINI

<b>RF 91</b>	<b>Cm<sup>3</sup></b>	<b>CILINDRI CYLINDERS</b>	<b>ALESAGGIO BORE</b>	<b>CORSA STROKE</b>	<b>VERSIONE VERSION</b>
	477	1	90	75	

	2140	2394			447.76	447.79	448.14	448.14
FIN110CGA	FIN110CGB	FIN084SM	FIN3216RT	FIN3215RT	FIN206CO	FIN281CB	FIN503IG	FIN503IG

 	ADATTABILE A: SUITABLE FOR:		<b>Nr.</b>	<b>ENGINE KIT</b>	<b>ELECTRIC KIT</b> 
	448.08	FIN6241HG	1	 FIN029SL00	
			1	 FIN197PC00	
			1	 FIN084SM	
			A2392	FIN0910KIT	

388.29	059.90	359.26	060.48	175.32	175.05		894.21
FIN290AF	FIN090PF	FIN821NF	FIN840CFA	FIN020FE	FIN4225OF		FIN023SF

100.36	2912			A2417			
FIN1060KR	FIN080CK			FIN028OP			

	656.41	644.38	644.37	660.20	956.51		
	FIN701JP	FIN502NH	FIN051NO	FIN059E	FIN098DV		

696.78							
FIN038PU	FIN003CN						

014.09	730.13	563.50	527.44				
FIN323VA	FIN238VR	FIN142TL	FIN112SI				

Ricambi non originali per motori. Denominazioni e codici originali, sono riportati a puro titolo di riferimento.





14 - 17





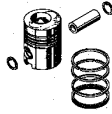
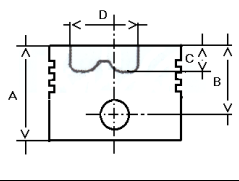

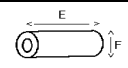
rel. 609

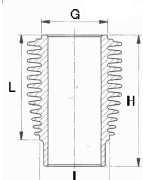
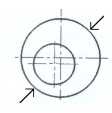
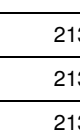
Non original engine parts. OEMs names and part numbers are for reference purpose only.

# RUGGERINI

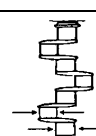
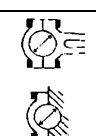
<b>RF 100</b>	<b>Cm<sup>3</sup></b>	<b>CILINDRI CYLINDERS</b>	<b>ALESAGGIO BORE</b>	<b>CORSA STROKE</b>	<b>VERSIONE VERSION</b>
		1	85		

		<b>TESTA HEAD</b>	H43		3	2,5	<b>TIPO TYPE</b>	A	
		A	88		10	2,5			
<b>FIN202PN</b> 854.11		B	50		10	2,5		G	105
		C	12		10	2,5		H	165,5
		D	44		22	5	<b>203.10</b>	I	98
		E	74		2135	FIN069RS00		L	122,4
		F	25		2136	FIN069RS05		<b>FIN489SL00</b>	
85	2130	FIN192PC00	2137	FIN069RS10					
85,5	2131	FIN192PC05							
86	2132	FIN192PC10							

		<b>Nr.</b>						ADATTABILE A: SUITABLE FOR:	
---	---	------------	---	---	---	---	---	--------------------------------	---

CR	AL	1	45,00	48,01	24,12		STD - 025 - 050 - 075 - 100 - BAR	316.36	FIN036CR STD
----	----	---	-------	-------	-------	--	-----------------------------------	--------	--------------

MB	ALL	2	42,09	50,03	40,20		STD - 025 - 050 - 075 - 100 - BAR - BAR EM1	310.16	FIN016MB STD
----	-----	---	-------	-------	-------	--	---	--------	--------------





--	--	--	--	--	--	--	--	--	--



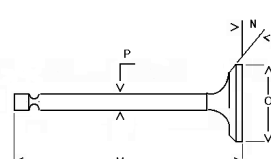

--	--	--	--	--	--	--	--	--	--

PB	BM	1	25,02	28,02	27,50		SEMIF.	316.41	FIN141PB
----	----	---	-------	-------	-------	--	--------	--------	----------

--	--	--	--	--	--	--	--	--	--

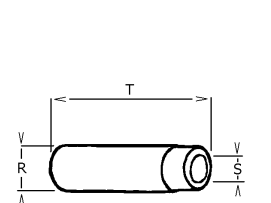
--	--	--	--	--	--	--	--	--	--

	<b>IN EX</b>		<b>Nr.</b>	<b>O</b>	<b>P</b>	<b>M</b>	<b>N</b>		ADATTABILE A: SUITABLE FOR:			
	IN		FS	1	35	9	105		45	E1	960.16	FINA116
	EX		FN	1	35	9	105		45	A1	960.15	FINS117

	<b>IN EX</b>		<b>Nr.</b>	<b>R</b>	<b>S</b>	<b>T</b>		ADATTABILE A: SUITABLE FOR:			
	IN		G	1	15,03	9,04		45	L	464.39	FIN203AA
	IN		G		15,13	9,04		45	L	464.25	FIN203AB
	EX		G	1	15,03	9,04		45	L	464.40	FIN204SA
	EX		G		15,13	9,04		45	L	464.35	FIN204SB

Ricambi non originali per motori. Denominazioni e codici originali, sono riportati a puro titolo di riferimento.

**15 - 17**

rel. 609

Non original engine parts. OEMs names and part numbers are for reference purpose only.

# RUGGERINI

<b>RF 100</b>	<b>Cm<sup>3</sup></b>	<b>CILINDRI CYLINDERS</b>	<b>ALESAGGIO BORE</b>	<b>CORSA STROKE</b>	<b>VERSIONE VERSION</b>
		1	85		

	2119	2393			447.76	447.79	448.14	448.14
FIN108CGA	FIN108CGB	FIN082SM	FIN3216RT	FIN3215RT	FIN206CO	FIN281CB	FIN503IG	FIN503IG

 	ADATTABILE A: SUITABLE FOR:		<b>Nr.</b>	<b>ENGINE KIT</b>	<b>ELECTRIC KIT</b> 
	447.78	FIN6380HG	1	 FIN489SL00	
			1	 FIN192PC00	
			1	 FIN082SM	
				FIN0902KIT	

387.92	059.73	359.24		175.23	175.05		
FIN2212AF	FIN5014PF	FIN1035NF		FIN4231FE	FIN4225OF		

100.23	2955			2122			
FIN1065KR	FIN085CK			FIN022OP			

	656.42	644.32	644.34	660.17	956.05		
	FIN702JP	FIN504NH	FIN098NO	FIN011E	FIN016DV		

696.54							
FIN052PU	FIN003CN						

			526.66				
			FIN113SI				

Ricambi non originali per motori. Denominazioni e codici originali, sono riportati a puro titolo di riferimento.

**16 - 17**

rel. 609

*Non original engine parts. OEMs names and part numbers are for reference purpose only.*

# RUGGERINI

<b>RF 120</b>	<b>Cm<sup>3</sup></b>	<b>CILINDRI CYLINDERS</b>	<b>ALESAGGIO BORE</b>	<b>CORSA STROKE</b>	<b>VERSIONE VERSION</b>
	540	1	90	85	

		<b>TESTA HEAD</b>	H29			<b>TIPO TYPE</b>		A	
		A	85			G	105		
		B	50			H	165,6		
		C	17			I	98		
		D	42			L	122,4		
		E	74			203.12		FIN028SL00	
FIN202PN		FIN196PC00		2149	FIN071RS00				
854.11		FIN196PC05		2150	FIN071RS05				
		FIN196PC10		2151	FIN071RS10				
	90	A2099							
	90,5	A2100							
	91	A2101							

		<b>Nr.</b>							ADATTABILE A: SUITABLE FOR:	
--	--	------------	--	--	--	--	--	--	--------------------------------	--

CR	AL	1	45,00	48,00	24,12			STD - 025 - 050 - 075 - 100	316.70	FIN2260CR STD
----	----	---	-------	-------	-------	--	--	-----------------------------	--------	---------------

MB	RP	2	42,09	50,03	26,00			STD - 025 - 050	311.01	FIN001MB STD
----	----	---	-------	-------	-------	--	--	-----------------	--------	--------------

MB	ALL	2	42,09	50,03	40,20			STD - 025 - 050 - 075 - 100 - BAR - BAR EM1	310.16	FIN016MB STD
----	-----	---	-------	-------	-------	--	--	---	--------	--------------

SOLUZIONE ALTERNATIVA <b>FIN016MB = FIN001MB + FIN002TW</b> ALTERNATIVE SOLUTION									
--	--	--	--	--	--	--	--	--	--

PB	BM	1	25,02	28,02	27,50			SEMIF.	316.41	FIN141PB
----	----	---	-------	-------	-------	--	--	--------	--------	----------

TW	AL	1	50,00	63,00	3,00			STD	060.39	FIN002TW STD
----	----	---	-------	-------	------	--	--	-----	--------	--------------

--	--	--	--	--	--	--	--	--	--	--

	<b>IN EX</b>		<b>Nr.</b>	<b>O</b>	<b>P</b>	<b>M</b>	<b>N</b>		ADATTABILE A: SUITABLE FOR:			
	IN		FS	1	39	7	95		45	A1	960.56	FINA160
	EX		FN	1	36	7	95		45	A1	960.55	FINS161

	<b>IN EX</b>		<b>Nr.</b>	<b>R</b>	<b>S</b>	<b>T</b>		ADATTABILE A: SUITABLE FOR:			
	IN		G	1	13,05	7,03		39	I	464.77	FIN208ASA
	IN		G		13,15	7,03		39	I	464.59	FIN208ASB
	EX		G	1	13,05	7,03		39	I	464.77	FIN208ASA
	EX		G		13,15	7,03		39	I	464.59	FIN208ASB

Ricambi non originali per motori. Denominazioni e codici originali, sono riportati a puro titolo di riferimento.

**17 - 17**

rel. 609

Non original engine parts. OEMs names and part numbers are for reference purpose only.

# RUGGERINI

<b>RF 120</b>	<b>Cm<sup>3</sup></b>	<b>CILINDRI CYLINDERS</b>	<b>ALESAGGIO BORE</b>	<b>CORSA STROKE</b>	<b>VERSIONE VERSION</b>
	540	1	90	85	

	2140	2394			447.76	447.79	448.14	448.14
FIN110CGA	FIN110CGB	FIN084SM	FIN3216RT	FIN3215RT	FIN206CO	FIN281CB	FIN503IG	FIN503IG

 ↓ === ↑	ADATTABILE A: SUITABLE FOR:		<b>Nr.</b>	<b>ENGINE KIT</b>	<b>ELECTRIC KIT</b> 
	448.08	FIN6241HG	1	 FIN028SL00	
			1	 FIN196PC00	
			1	 FIN084SM	
			A2394	FIN0927KIT	

388.29	059.90	359.26	060.48	175.23	175.05		894.21
FIN290AF	FIN090PF	FIN821NF	FIN840CFA	FIN4231FE	FIN4225OF		FIN023SF

100.23	2955			A2417			
FIN1065KR	FIN085CK			FIN028OP			

	656.42	644.38	644.37	660.17	956.27		
	FIN702JP	FIN502NH	FIN051NO	FIN011E	FIN016DV		

696.54							
FIN052PU	FIN003CN						

014.09	730.13	563.50	527.44				
FIN323VA	FIN238VR	FIN142TL	FIN112SI				

Ricambi non originali per motori. Denominazioni e codici originali, sono riportati a puro titolo di riferimento.

**18 - 17**

rel. 609

*Non original engine parts. OEMs names and part numbers are for reference purpose only.*

# RUGGERINI

<b>RF 121</b>	<b>Cm<sup>3</sup></b>	<b>CILINDRI CYLINDERS</b>	<b>ALESAGGIO BORE</b>	<b>CORSA STROKE</b>	<b>VERSIONE VERSION</b>
	540	1	90	85	

		<b>TESTA HEAD</b>	A	85			<b>TIPO TYPE</b>  A
			B	50			
			C	17			
			D	42			
			E	74			
			F	25			
	FIN202PN						
	854.11						
	90	A2099	FIN196PC00		2149	FIN071RS00	
	90,5	A2100	FIN196PC05		2150	FIN071RS05	
	91	A2101	FIN196PC10		2151	FIN071RS10	
					203.12	FIN028SL00	

		<b>Nr.</b>							ADATTABILE A: SUITABLE FOR:	
--	--	------------	--	--	--	--	--	--	--------------------------------	--

CR	AL	1	45,00	48,00	24,12		STD - 025 - 050 - 075 - 100	316.70	FIN2260CR STD
----	----	---	-------	-------	-------	--	-----------------------------	--------	---------------

MB	RP	2	42,09	50,03	26,00		STD - 025 - 050	311.01	FIN001MB STD
----	----	---	-------	-------	-------	--	-----------------	--------	--------------

MB	ALL	2	42,09	50,03	40,20		STD - 025 - 050 - 075 - 100 - BAR - BAR EM1	310.16	FIN016MB STD
----	-----	---	-------	-------	-------	--	---	--------	--------------

SOLUZIONE ALTERNATIVA <b>FIN016MB = FIN001MB + FIN002TW</b> ALTERNATIVE SOLUTION									
--	--	--	--	--	--	--	--	--	--

PB	BM	1	25,02	28,02	27,50		SEMIF.	316.41	FIN141PB
----	----	---	-------	-------	-------	--	--------	--------	----------

TW	AL	1	50,00	63,00	3,00		STD	060.39	FIN002TW STD
----	----	---	-------	-------	------	--	-----	--------	--------------

--	--	--	--	--	--	--	--	--	--

	<b>IN EX</b>		<b>Nr.</b>	<b>O</b>	<b>P</b>	<b>M</b>	<b>N</b>		ADATTABILE A: SUITABLE FOR:								
	IN								FS	1	39	7	95	45	A1	960.56	FINA160
	EX								FN	1	36	7	95	45	A1	960.55	FINS161

	<b>IN EX</b>		<b>Nr.</b>	<b>R</b>	<b>S</b>	<b>T</b>		ADATTABILE A: SUITABLE FOR:							
	IN							G	1	13,05	7,03	39	I	464.77	FIN208ASA
	IN							G		13,15	7,03	39	I	464.59	FIN208ASB
	EX							G	1	13,05	7,03	39	I	464.77	FIN208ASA
	EX							G		13,15	7,03	39	I	464.59	FIN208ASB

Ricambi non originali per motori. Denominazioni e codici originali, sono riportati a puro titolo di riferimento.

**19 - 17**

rel. 609

Non original engine parts. OEMs names and part numbers are for reference purpose only.

# RUGGERINI

<b>RF 121</b>	<b>Cm<sup>3</sup></b>	<b>CILINDRI CYLINDERS</b>	<b>ALESAGGIO BORE</b>	<b>CORSA STROKE</b>	<b>VERSIONE VERSION</b>
	540	1	90	85	

	2140	2394			447.76	447.79	448.14	448.14
FIN110CGA	FIN110CGB	FIN084SM	FIN3216RT	FIN3215RT	FIN206CO	FIN281CB	FIN503IG	FIN503IG

 ↓ === ↑	ADATTABILE A: SUITABLE FOR:		<b>Nr.</b>	<b>ENGINE KIT</b>	<b>ELECTRIC KIT</b> 
	448.08	FIN6241HG	1	 FIN028SL00	
			1	 FIN196PC00	
			1	 FIN084SM	
			A2394	FIN0927KIT	

388.29	059.90	359.26	060.48	175.23	175.05		894.21
FIN290AF	FIN090PF	FIN821NF	FIN840CFA	FIN4231FE	FIN4225OF		FIN023SF

100.23	2955			A2417			
FIN1065KR	FIN085CK			FIN028OP			

	656.42	644.38	644.37	660.17	956.27		
	FIN702JP	FIN502NH	FIN051NO	FIN011E	FIN016DV		

696.54							
FIN052PU	FIN003CN						

014.09	730.13	563.50	527.44				
FIN323VA	FIN238VR	FIN142TL	FIN112SI				

Ricambi non originali per motori. Denominazioni e codici originali, sono riportati a puro titolo di riferimento.

**20 - 17**



rel. 609







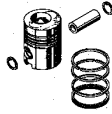
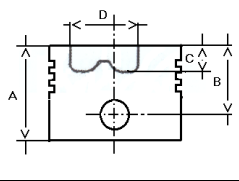

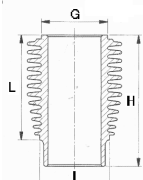
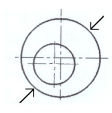
*Non original engine parts. OEMs names and part numbers are for reference purpose only.*

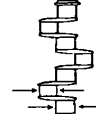

# RUGGERINI

<b>RF 130</b>	<b>Cm<sup>3</sup></b>	<b>CILINDRI CYLINDERS</b>	<b>ALESAGGIO BORE</b>	<b>CORSA STROKE</b>	<b>VERSIONE VERSION</b>
		1	92	85	

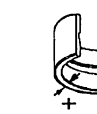
		<b>TESTA HEAD</b> A 50 B 16,7 C 42 E 74 F 25		3 2,5 10 2,5 10 2,5 22 5	<b>TIPO TYPE</b> 	A G 105 H 165,6 I 98 L 122,4
	92 A2103 92,5 A2104 93 A2105	FIN200PC00 FIN200PC05 FIN200PC10				

		<b>Nr.</b>						ADATTABILE A: SUITABLE FOR:	
--	---	------------	---	---	---	---	---	--------------------------------	---

CR	AL	1	45,00	48,01	24,12		STD - 025 - 050 - 075 - 100 - BAR	316.36	FIN036CR STD
----	----	---	-------	-------	-------	--	-----------------------------------	--------	--------------

MB	ALL	2	42,09	50,03	40,20		STD - 025 - 050 - 075 - 100 - BAR - BAR EM1	310.16	FIN016MB STD
----	-----	---	-------	-------	-------	--	---	--------	--------------





--	--	--	--	--	--	--	--	--	--



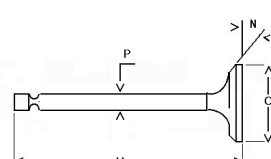

--	--	--	--	--	--	--	--	--	--

PB	BM	1	25,02	28,02	27,50		SEMIF.	316.41	FIN141PB
----	----	---	-------	-------	-------	--	--------	--------	----------

--	--	--	--	--	--	--	--	--	--

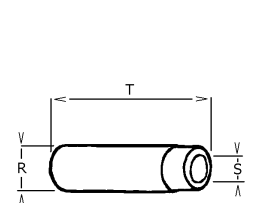
--	--	--	--	--	--	--	--	--	--

	<b>IN EX</b>		<b>Nr.</b>	<b>O</b>	<b>P</b>	<b>M</b>	<b>N</b>		ADATTABILE A: SUITABLE FOR:				
	IN		FS	1	39	7	95		45		A1	960.56	FINA160
	EX		FN	1	36	7	95		45		A1	960.55	FINS161

	<b>IN EX</b>		<b>Nr.</b>	<b>R</b>	<b>S</b>	<b>T</b>		ADATTABILE A: SUITABLE FOR:				
	IN		G	1	13,05	7,03		39		I	464.77	FIN208ASA
	IN		G		13,15	7,03		39		I	464.59	FIN208ASB
	EX		G	1	13,05	7,03		39		I	464.77	FIN208ASA
	EX		G		13,15	7,03		39		I	464.59	FIN208ASB

Ricambi non originali per motori. Denominazioni e codici originali, sono riportati a puro titolo di riferimento.

21 - 17

rel. 609

Non original engine parts. OEMs names and part numbers are for reference purpose only.

# RUGGERINI

<b>RF 130</b>	<b>Cm<sup>3</sup></b>	<b>CILINDRI CYLINDERS</b>	<b>ALESAGGIO BORE</b>	<b>CORSA STROKE</b>	<b>VERSIONE VERSION</b>
		1	92	85	

	2140	2394			447.76	447.79	448.14	448.14
FIN110CGA	FIN110CGB	FIN084SM	FIN3216RT	FIN3215RT	FIN206CO	FIN281CB	FIN503IG	FIN503IG

 	ADATTABILE A: SUITABLE FOR:		<b>Nr.</b>	<b>ENGINE KIT</b>	<b>ELECTRIC KIT</b> 
	448.08	FIN6241HG	1	 FIN031SL00	
			1	 FIN200PC00	
			1	 FIN084SM	
				FIN3246KIT	

388.40	060.06	359.30	060.13	175.23	175.05		
FIN290AF	FIN090PF	FIN1030NF	FIN600CFA	FIN4231FE	FIN4225OF		

100.23				2122			
FIN1065KR				FIN022OP			

	656.42	644.38	644.37	660.17	956.27		
	FIN702JP	FIN502NH	FIN051NO	FIN011E	FIN016DV		

696.54							
FIN052PU	FIN003CN						

			526.66				
			FIN113SI				

Ricambi non originali per motori. Denominazioni e codici originali, sono riportati a puro titolo di riferimento.

**22 - 17**

rel. 609

*Non original engine parts. OEMs names and part numbers are for reference purpose only.*

# RUGGERINI

<b>RF 140</b>	<b>Cm<sup>3</sup></b>	<b>CILINDRI CYLINDERS</b>	<b>ALESAGGIO BORE</b>	<b>CORSA STROKE</b>	<b>VERSIONE VERSION</b>
	602	1	95	85	

		<b>TESTA HEAD</b>	H13			<b>TIPO TYPE</b>	A	
		A	95				G	105
		B	50				H	165,6
		C	16,8				I	100
		D	41,6				L	122,4
		E	74				203.42	
854.11	F	25						
	95	A2107	FIN203PC00	2495	FIN076RS00			
	95,5	A2108	FIN203PC05	2496	FIN076RS05			
	96	A2109	FIN203PC10	2497	FIN076RS10			

		<b>Nr.</b>							ADATTABILE A: SUITABLE FOR:	
--	--	------------	--	--	--	--	--	--	--------------------------------	--

CR	AL	1	45,00	48,00	24,12		STD - 025 - 050 - 075 - 100	316.70	FIN2260CR STD
----	----	---	-------	-------	-------	--	-----------------------------	--------	---------------

MB	RP	2	42,09	50,03	26,00		STD - 025 - 050	311.01	FIN001MB STD
----	----	---	-------	-------	-------	--	-----------------	--------	--------------

MB	ALL	2	42,09	50,03	40,20		STD - 025 - 050 - 075 - 100 - BAR - BAR EM1	310.16	FIN016MB STD
----	-----	---	-------	-------	-------	--	---	--------	--------------

<b>SOLUZIONE ALTERNATIVA FIN016MB = FIN001MB + FIN002TW ALTERNATIVE SOLUTION</b>									
--	--	--	--	--	--	--	--	--	--

PB	BM	1	25,02	28,02	27,50		SEMIF.	316.41	FIN141PB
----	----	---	-------	-------	-------	--	--------	--------	----------

TW	AL	1	50,00	63,00	3,00		STD	060.39	FIN002TW STD
----	----	---	-------	-------	------	--	-----	--------	--------------

--	--	--	--	--	--	--	--	--	--

	<b>IN EX</b>		<b>Nr.</b>	<b>O</b>	<b>P</b>	<b>M</b>	<b>N</b>		ADATTABILE A: SUITABLE FOR:			
	IN		FS	1	39	7	95		45	A1	960.56	FINA160
	EX		FN	1	36	7	95		45	A1	960.55	FINS161

	<b>IN EX</b>		<b>Nr.</b>	<b>R</b>	<b>S</b>	<b>T</b>		ADATTABILE A: SUITABLE FOR:			
	IN		G	1	13,05	7,03		39	I	464.77	FIN208ASA
	IN		G		13,15	7,03		39	I	464.59	FIN208ASB
	EX		G	1	13,05	7,03		39	I	464.77	FIN208ASA
	EX		G		13,15	7,03		39	I	464.59	FIN208ASB

Ricambi non originali per motori. Denominazioni e codici originali, sono riportati a puro titolo di riferimento.

**23 - 17**

rel. 609

Non original engine parts. OEMs names and part numbers are for reference purpose only.

# RUGGERINI

<b>RF 140</b>	<b>Cm<sup>3</sup></b>	<b>CILINDRI CYLINDERS</b>	<b>ALESAGGIO BORE</b>	<b>CORSA STROKE</b>	<b>VERSIONE VERSION</b>
	602	1	95	85	

	2482	2483			447.76	447.79	448.14	448.14
FIN115CGA	FIN115CGB	FIN089SM	FIN3216RT	FIN3215RT	FIN206CO	FIN281CB	FIN503IG	FIN503IG

 	ADATTABILE A: SUITABLE FOR:		<b>Nr.</b>	<b>ENGINE KIT</b>	<b>ELECTRIC KIT</b> 
	449.52	FIN625HG	1	 FIN033SL00	
			1	 FIN203PC00	
			1	 FIN089SM	
			A2403	FIN0951KIT	

388.29	059.90	359.26	060.48	175.23	175.05		894.21
FIN290AF	FIN5013PF	FIN821NF	FIN840CFA	FIN4231FE	FIN4225OF		FIN023SF

100.23				A2417			
FIN1065KR				FIN028OP			

	656.42	644.38	644.37	660.17	956.27		
	FIN702JP	FIN502NH	FIN051NO	FIN011E	FIN016DV		

696.54							
FIN052PU	FIN003CN						

014.09	730.13	563.50	526.66				
FIN323VA	FIN238VR	FIN142TL	FIN113SI				

Ricambi non originali per motori. Denominazioni e codici originali, sono riportati a puro titolo di riferimento.



**24 - 17**







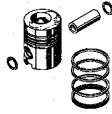
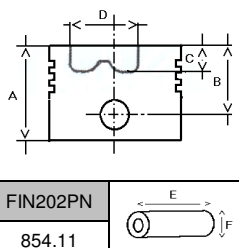

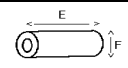
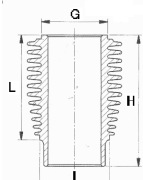
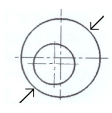
rel. 609

*Non original engine parts. OEMs names and part numbers are for reference purpose only.*

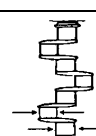
# RUGGERINI

<b>RF 148</b>	<b>Cm<sup>3</sup></b>	<b>CILINDRI CYLINDERS</b>	<b>ALESAGGIO BORE</b>	<b>CORSA STROKE</b>	<b>VERSIONE VERSION</b>
	602	1	95	85	

		<b>TESTA HEAD</b>	H13		3	2,5	<b>TIPO TYPE</b>	<b>A</b>			
		A	95		10	2,5					
		B	50		10	2,5					
		C	16,8		21	5,5					
		D	41,6								
		E	74								
FIN202PN		F	25					G	105		
854.11						H		165,6			
								I	100		
							L	122,4			
	95	A2107	FIN203PC00		2495	FIN076RS00		203.42		FIN033SL00	
	95,5	A2108	FIN203PC05		2496	FIN076RS05					
	96	A2109	FIN203PC10		2497	FIN076RS10					

		<b>Nr.</b>						ADATTABILE A: SUITABLE FOR:	
--	---	------------	---	---	---	---	---	--------------------------------	---

CR	AL	1	45,00	48,01	24,12		STD - 025 - 050 - 075 - 100 - BAR	316.36	FIN036CR STD
----	----	---	-------	-------	-------	--	-----------------------------------	--------	--------------

MB	ALL	2	42,09	50,03	40,20		STD - 025 - 050 - 075 - 100 - BAR - BAR EM1	310.16	FIN016MB STD
----	-----	---	-------	-------	-------	--	---	--------	--------------





--	--	--	--	--	--	--	--	--	--



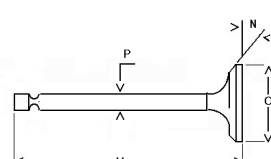

--	--	--	--	--	--	--	--	--	--

PB	BM	1	25,02	28,02	27,50		SEMIF.	316.41	FIN141PB
----	----	---	-------	-------	-------	--	--------	--------	----------

--	--	--	--	--	--	--	--	--	--

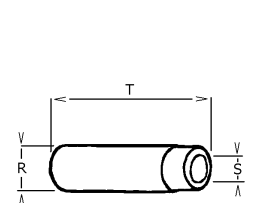
--	--	--	--	--	--	--	--	--	--

	<b>IN EX</b>		<b>Nr.</b>	<b>O</b>	<b>P</b>	<b>M</b>	<b>N</b>		ADATTABILE A: SUITABLE FOR:			
	IN		FS	1	39	7	95		45	A1	960.56	FINA160
	EX		FN	1	36	7	95		45	A1	960.55	FINS161

	<b>IN EX</b>		<b>Nr.</b>	<b>R</b>	<b>S</b>	<b>T</b>		ADATTABILE A: SUITABLE FOR:			
	IN		G	1	13,05	7,03		39	I	464.77	FIN208ASA
	IN		G		13,15	7,03		39	I	464.59	FIN208ASB
	EX		G	1	13,05	7,03		39	I	464.77	FIN208ASA
	EX		G		13,15	7,03		39	I	464.59	FIN208ASB

Ricambi non originali per motori. Denominazioni e codici originali, sono riportati a puro titolo di riferimento.

**25 - 17**

rel. 609

Non original engine parts. OEMs names and part numbers are for reference purpose only.

# RUGGERINI

<b>RF 148</b>	<b>Cm<sup>3</sup></b>	<b>CILINDRI CYLINDERS</b>	<b>ALESAGGIO BORE</b>	<b>CORSA STROKE</b>	<b>VERSIONE VERSION</b>
	602	1	95	85	

	2482	2483			447.76	447.79	448.14	448.14
FIN115CGA	FIN115CGB	FIN089SM	FIN3216RT	FIN3215RT	FIN206CO	FIN281CB	FIN503IG	FIN503IG

 	ADATTABILE A: SUITABLE FOR:		<b>Nr.</b>	<b>ENGINE KIT</b>	<b>ELECTRIC KIT</b> 
	449.52	FIN625HG	1	 FIN033SL00	
			1	 FIN203PC00	
			1	 FIN089SM	
			A2403	FIN0951KIT	

388.40		359.30		175.23	175.05		
FIN290AF		FIN1030NF		FIN4231FE	FIN4225OF		

100.23				2122			
FIN1065KR				FIN022OP			

	656.42	644.51	644.52	660.17	956.27		
	FIN702JP	FIN503NH	FIN051NO	FIN011E	FIN016DV		

696.54							
FIN052PU	FIN003CN						

			526.66				
			FIN113SI				

Ricambi non originali per motori. Denominazioni e codici originali, sono riportati a puro titolo di riferimento.

**26 - 17**

rel. 609

*Non original engine parts. OEMs names and part numbers are for reference purpose only.*

# RUGGERINI

**MC – RF**

**ALTRI ARTICOLI**

**OTHERS ITEMS**

POS.	ARTICOLO	ITEM	MOTORE ENGINE	CODICE FINIMPIANTI FINIMPIANTI REF.	ADATTABILE A SUITABLE FOR:
1	Cartuccia filtro combustibile	<i>Fuel filter cartridge</i>	RF 120 , RF 121, RF 140	FIN4226FE	175.28
2	Anello asta bilanciere	<i>Guard tube seal</i>	All models	FIN082AP	579.10
3	Cappuccio Valvola	<i>Valve cap</i>	All models	FIN119CV	451.25
4	Kit anelli di tenuta	<i>Seal rings kit</i>	All models	FIN3217RTS ( FIN3215RT + FIN3216RT )	2118
5					
6					
7					
8					
9					
10					
11					
12					
13					
14					
15					
16					
17					
18					
19					
21					
22					

# RUGGERINI

**MC – RF**

**ALTRI ARTICOLI**

***OTHERS ITEMS***

POS.	ARTICOLO	<i>ITEM</i>	MOTORE <i>ENGINE</i>	CODICE FINIMPIANTI <i>FINIMPIANTI REF.</i>	ADATTABILE A <i>SUITABLE FOR:</i>
23					
24					
25					
26					
27					
28					
29					
30					
31					
32					
33					
34					
35					
36					
37					
38					
39					
40					
41					





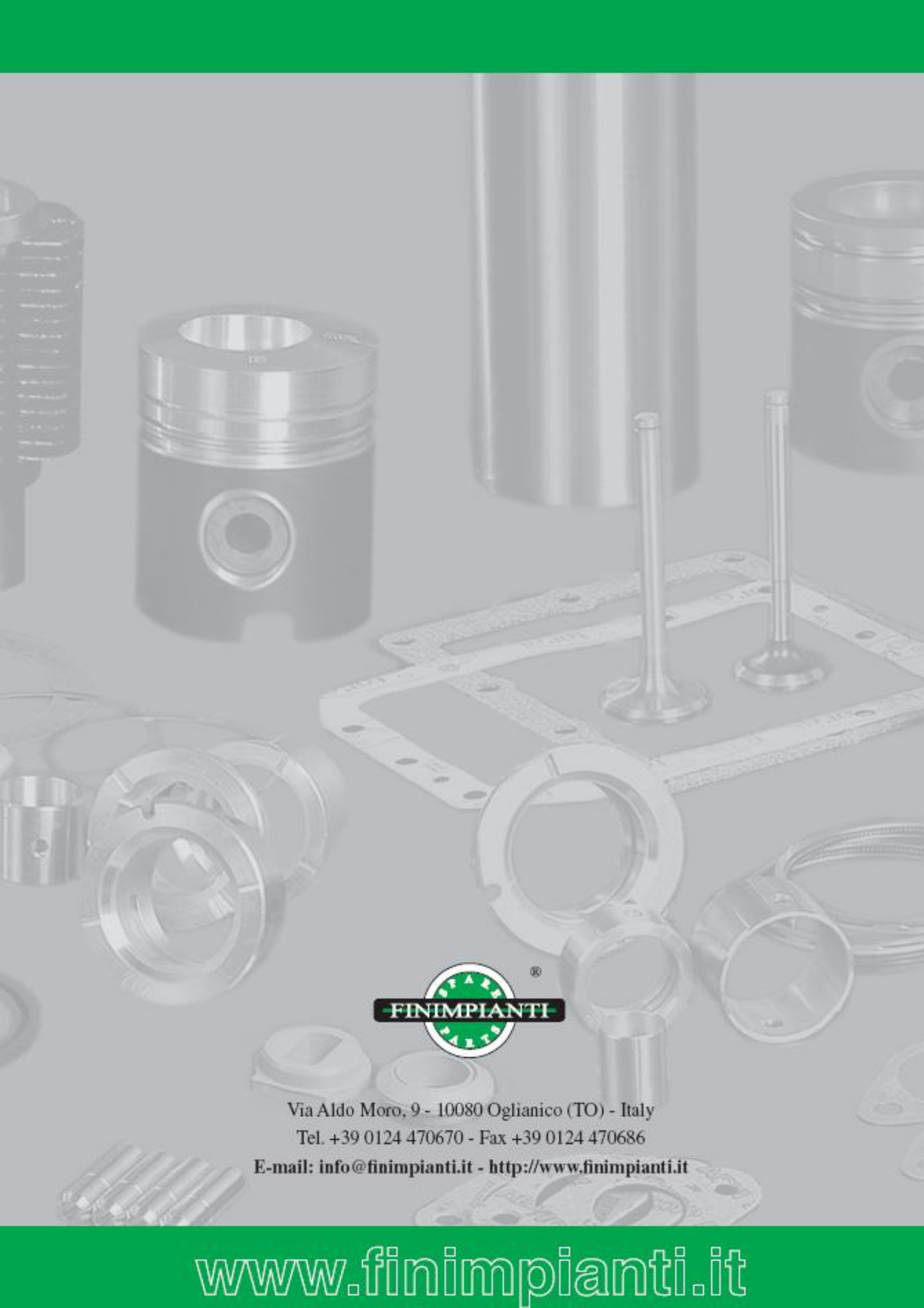

Via Aldo Moro, 9 - 10080 Oglianico (TO) - Italy

Tel. +39 0124 470670 - Fax +39 0124 470686

E-mail: [info@finimpianti.it](mailto:info@finimpianti.it) - <http://www.finimpianti.it>

[www.finimpianti.it](http://www.finimpianti.it)