



Quality Parts

GRUPPO 103

65

103 FAMILY

RICAMBI ALTERNATIVI PER

MOTORI SAME SLH

NON ORIGINAL PARTS FOR

SAME SLH ENGINES

REL 905

Questo catalogo contiene dati ed informazioni provenienti dalla pluriennale esperienza di Finimpianti. Tuttavia non possiamo assumere alcuna responsabilità per eventuali dati errati od incompleti.

Tutti i dati e le informazioni contenute nel presente catalogo sono fornite a puro scopo informativo e senza responsabilità e non potranno dare adito ad alcuna forma di risarcimento.

Visto il continuo sviluppo dei nostri prodotti, Finimpianti si riserva il diritto di apportare modifiche senza preavviso.

Denominazioni, numeri e codici originali sono riportati a puro titolo di riferimento.

All the information and data contained in this catalogue came from the long Finimpianti experience. Nevertheless we can not assume any responsibility for possible mistakes.

All the information and data contained in this catalogue are provide "as is" without any representation or warranty express or implied. Under no circumstances whatsoever shall Finimpianti be liable for any damages whatsoever arising out of the use of the information and data contained in this catalogue.

Finimpianti does not warrant the accuracy or completeness of the materials and content contained in this catalogue and reserves the right to correct any errors or omissions at any time without notice and without obligation to the users of this catalogue.

OEM names, codes and part numbers, used in this catalogue, are for reference only.

**GRUPPO 103
SAME
103 FAMILY**

1	916.4 A (077.00)	
3	916.6 W 1 , 916.6 W 2	100HP : 3528 ← 110HP : 1463 ←
5	916.6 W 1 , 916.6 W 2	100HP : 3529 → 110HP : 1464 →
7	916.6 W 1 , 916.6 W 2	100HP : 3643 → 110HP : 1966 →
9	916.6 W T	130HP : 1764 ←
11	916.6 W T	130HP : 1765 → 1802
13	916.6 W T	130HP : 1803 →

Questo catalogo contiene dati ed informazioni provenienti dalla pluriennale esperienza di Finimpianti. Tuttavia non possiamo assumere alcuna responsabilità per eventuali dati errati od incompleti.

Tutti i dati e le informazioni contenute nel presente catalogo sono fornite a puro scopo informativo e senza responsabilità e non potranno dare adito ad alcuna forma di risarcimento.

Visto il continuo sviluppo dei nostri prodotti, Finimpianti si riserva il diritto di apportare modifiche senza preavviso.

Denominazioni, numeri e codici originali sono riportati a puro titolo di riferimento.

All the information and data contained in this catalogue came from the long Finimpianti experience. Nevertheless we can not assume any responsibility for possible mistakes.



All the information and data contained in this catalogue are provide "as is" without any representation or warranty express or implied. Under no circumstances whatsoever shall Finimpianti be liable for any damages whatsoever arising out of the use of the information and data contained in this catalogue.







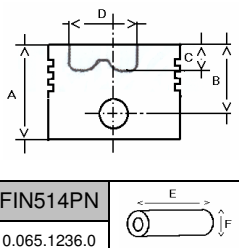

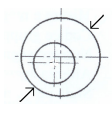
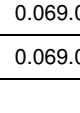
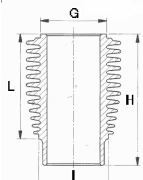
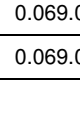
Finimpianti does not warrant the accuracy or completeness of the materials and content contained in this catalogue and reserves the right to correct any errors or omissions at any time without notice and without obligation to the users of this catalogue.

OEM names, codes and part numbers, used in this catalogue, are for reference only.

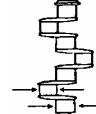
SAME

916.4 A (077.00)	Cm³	CILINDRI CYLINDERS	ALESAGGIO BORE	CORSA STROKE	VERSIONE VERSION
	3666	4	103	110	

		TESTA HEAD	H20		3	3	TIPO TYPE	A	
		A	100		9	3			
	FIN514PN	E	77		23	4		G	116
	0.065.1236.0	F	32						H
	103	0.069.0060.6	FIN214PC00	0.069.0052.6		FIN085RS00		I	112,8
	103,5	0.069.0061.6	FIN214PC05	0.069.0053.6	FIN085RS05		L	72	
	104	0.069.0062.6	FIN214PC10		FIN085RS10		0.065.1120.0		FIN043SL00

		Nr.							ADATTABILE A: SUITABLE FOR:	
---	---	------------	---	---	---	---	---	--	--------------------------------	---

CR	RP	4	63,50	67,22	29,00			STD - 025 - 050 075 - 100	0.065.1225.0 + 0.065.1225.0	FIN478CR STD
----	----	---	-------	-------	-------	--	--	------------------------------	--------------------------------	--------------

MB	RP	5	70,00	74,02	26,25			STD - 025 - 050 075 - 100	0.065.1215.0 + 0.065.1216.0	FIN279MB STD
----	----	---	-------	-------	-------	--	--	------------------------------	--------------------------------	--------------





--	--	--	--	--	--	--	--	--	--	--



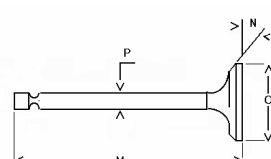

--	--	--	--	--	--	--	--	--	--	--

PB	BM	4	32,00	36,02	34,00			SEMIF.	0.065.1227.0	FIN5530PB
----	----	---	-------	-------	-------	--	--	--------	--------------	-----------

TWS	AL	2	82,25	100,00	2,36			STD - 010 - 020	0.065.1218.0 + 0.065.1218.0	FIN167TWS STD
-----	----	---	-------	--------	------	--	--	-----------------	--------------------------------	---------------

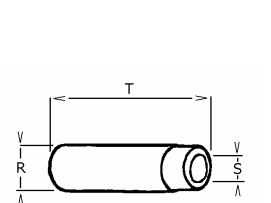
--	--	--	--	--	--	--	--	--	--	--

	IN EX		Nr.	O	P	M	N		ADATTABILE A: SUITABLE FOR:				
	IN		FSN	4	43	9	131		45°		A1	0.066.1420.0	FINA785
	EX		FSN	4	39,5	9	130,5		45°		A1	0.066.1421.0	FINS786

	IN EX		Nr.	R	S	T		ADATTABILE A: SUITABLE FOR:				
	IN		G	4	15,05	9,05		63		L	0.066.1416.0	FIN317ASA
	IN											
	EX		G	4	15,05	9,05		63		L	0.066.1416.0	FIN317ASA
EX												

Ricambi non originali per motori. Denominazioni e codici originali, sono riportati a puro titolo di riferimento.





1 - 65





rel. 905



Non original engine parts. OEMs names and part numbers are for reference purpose only.







SAME







916.4 A (077.00)	Cm³	CILINDRI CYLINDERS	ALESAGGIO BORE	CORSA STROKE	VERSIONE VERSION
	3666	4	103	110	

			
0.065.0050.6		2.1569.112.0	0.065.0057.7
FIN133CGA	FIN133CGB	FIN6265HG	FIN098SM

			
0.065.1550.0	0.066.1450.0	IN	EX
FIN5009CO	FIN3213CB		

Nr.	ENGINE KIT	
1		FIN043SL00
1		FIN214PC00
1		FIN098SM
0.065.0065.6		FIN2040KIT

						
2.1529.073.0	2.1529.072.0	2.4249.350.0/20	2.4329.110.0	2.4249.130.7	0.044.1567.0	2.4319.060.1
FIN2888RT	FIN2889RT	FIN8206AF	FIN8207PF	FIN8322NF	FIN8225OF	FIN8605FE

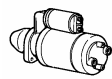
						
2.4519.300.0		2.4619.010.1	2.4729.100.0	2.4619.010.2	55A 2.9439.240.0	2.9619.230.0/10
FIN919FP		FIN1696E	FIN161NO	FIN1690DV	FIN2285VA	FIN1869TL

1	Guarnizione coperchio bilancieri	<i>Rocker box cap</i>	0.065.1450.0/30	FIN3208CB
2	Kit revisione pompa alimentazione	<i>Fuel pump repairing kit</i>	2.4519.269.0	FIN2919KFP
3	Filtro Olio Idraulico	<i>Hydraulic oil filter</i>	2.4419.350.0	FIN8210HF
4	Massa filtrante 8"	<i>Filtering element 8"</i>	2.4249.131.0	FIN8323NF
5	Alternatore 55A	<i>Alternator 55A</i>	2.9439.190.0	FIN2322VA
6	Alternatore 65A	<i>Alternator 65A</i>	2.9439.290.0	FIN2324VA
7				
8				
9				
10				
11				
12				
13				
14				
15				

Ricambi non originali per motori. Denominazioni e codici originali, sono riportati a puro titolo di riferimento.





2 - 65





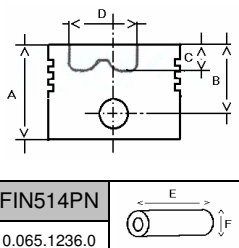

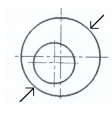
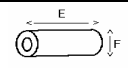

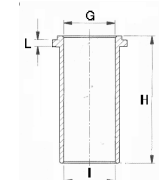
rel. 905

Non original engine parts. OEMs names and part numbers are for reference purpose only.

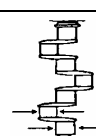
SAME

916.6 W1 916.6 W2	Cm³	CILINDRI CYLINDERS	ALESAGGIO BORE	CORSA STROKE	VERSIONE VERSION
	5500	6	103	110	100HP : 3528 ← 110HP : 1463 ←

		TESTA HEAD	H20		3	3	TIPO TYPE	CB		
					9	3				
	FIN514PN 0.065.1236.0		A	100		23	4		G	123
			B	60		0.069.0052.6	FIN085RS00		H	195
C	20,6	0.069.0053.6	FIN085RS05	I	114					
D	55			FIN085RS10	L	8				
E	77	0.066.1120.0/10	FIN044SL00							
F	32									
		103	0.069.0060.6	FIN214PC00						
		103,5	0.069.0061.6	FIN214PC05						
		104	0.069.0062.6	FIN214PC10						

		Nr.						ADATTABILE A: SUITABLE FOR:	
---	---	------------	---	---	---	---	---	--------------------------------	---

CR	RP	6	63,50	67,22	29,00		STD - 025 - 050 075 - 100	0.065.1225.0 + 0.065.1225.0	FIN478CR STD
----	----	---	-------	-------	-------	--	------------------------------	--------------------------------	--------------

MB	RP	7	70,00	74,02	26,25		STD - 025 - 050 075 - 100	0.065.1215.0 + 0.065.1216.0	FIN279MB STD
----	----	---	-------	-------	-------	--	------------------------------	--------------------------------	--------------





--	--	--	--	--	--	--	--	--	--



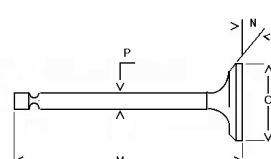

--	--	--	--	--	--	--	--	--	--

PB	BM	6	32,00	36,02	34,00		SEMIF.	0.065.1227.0	FIN5530PB
----	----	---	-------	-------	-------	--	--------	--------------	-----------

TWS	AL	2	82,25	100,00	2,36		STD - 010 - 020	0.065.1218.0 + 0.065.1218.0	FIN167TWS STD
-----	----	---	-------	--------	------	--	-----------------	--------------------------------	---------------

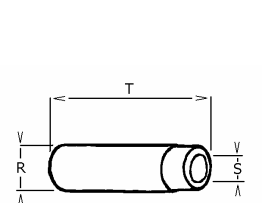
--	--	--	--	--	--	--	--	--	--

	IN EX		Nr.	O	P	M	N		ADATTABILE A: SUITABLE FOR:								
	IN								FSN	6	44	9	131	30°	A1	0.010.6016.0	FINA6040
	EX								FSN	6	39,5	9	130,5	45°	A1	0.066.1421.0	FINS786

	IN EX		Nr.	R	S	T		ADATTABILE A: SUITABLE FOR:							
	IN							G	6	15,03	9,02	60	I	0.007.1779.0/10	FIN6519ASA
	EX							G	6	15,03	9,02	60	I	0.007.1779.0/10	FIN6519ASA
	EX														

Ricambi non originali per motori. Denominazioni e codici originali, sono riportati a puro titolo di riferimento.





3 - 65





rel. 905



Non original engine parts. OEMs names and part numbers are for reference purpose only.







SAME







916.6 W1 916.6 W2	Cm³	CILINDRI CYLINDERS	ALESAGGIO BORE	CORSA STROKE	VERSIONE VERSION
	5500	6	103	110	100HP : 3528 ← 110HP : 1463 ←

		 1,3 mm	
See pos. 1	See pos. 2	0.078.1451.0/40	
Vedere pos. 1	Vedere pos. 2	FIN6268HG	

		 IN	 EX
	0.009.3877.0/10		
	FIN3211CB		

Nr.	ENGINE KIT	
1		FIN044SL00
1		FIN214PC00
		
	0.066.0065.6	FIN2041KIT

 LV	 LD					
2.1529.073.0	2.1529.072.0				0.044.1567.0	2.4319.130.1
FIN2888RT	FIN2889RT				FIN8225OF	FIN8722FE

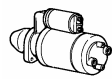
						
2.4519.300.0		2.4619.030.1	2.4729.100.0	2.4619.010.2	2.9439.570.0	2.9619.380.0
FIN919FP		FIN1695E	FIN161NO	FIN1690DV	FIN2382VA	FIN1873TL

1	Serie guarnizione motore con anelli di tenuta, senza guarnizione testa	Gasket set with seal rings, without head gasket	0.075.0050.6	FIN4295SHA
2	Serie guarnizione motore senza anelli di tenuta, senza guarnizione testa	Gasket set without seal rings, without head gasket		FIN4295SHB
3	Guarnizione testa 1,5 mm	Head Gasket 1,5 mm	0.078.1452.0/30	FIN6269HG
4	Guarnizione testa 1,8 mm	Head Gasket 1,8 mm	0.078.1453.0/40	FIN6270HG
5	OR per canna (107,67X1,78)	Liner O ring (107,67X1,78)	2.1519.096.0/10	FIN1096OR
6	Kit revisione pompa alimentazione	Fuel pump repairing kit	2.4519.269.0	FIN2919KFP
7	Cartuccia Filtro Combustibile	Fuel Filter Cartridge	2.4319.220.3	FIN8241FE
8				
9				
10				
11				
12				
13				
14				
15				

Ricambi non originali per motori. Denominazioni e codici originali, sono riportati a puro titolo di riferimento.



4 - 65







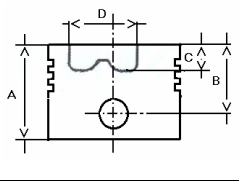

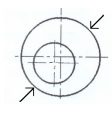
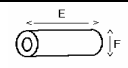
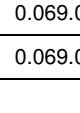
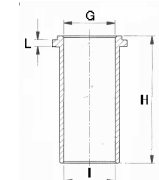
rel. 905

Non original engine parts. OEMs names and part numbers are for reference purpose only.

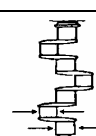
SAME

916.6 W1 916.6 W2	Cm³	CILINDRI CYLINDERS	ALESAGGIO BORE	CORSA STROKE	VERSIONE VERSION
	5500	6	103	110	100HP : 3529 → 110HP : 1464 →

		TESTA HEAD	H20		3	3	TIPO TYPE	CB		
					9	3				
	FIN514PN 0.065.1236.0		A	100		23	4		G	123
			B	60		0.069.0052.6	FIN085RS00		H	195
C	20,6	0.069.0053.6	FIN085RS05	I	114					
D	55			0.066.1120.0/30	FIN085RS10	L	8			
E	77	FIN214PC00				FIN1965SL00				
F	32									
103		0.069.0060.6	FIN214PC05		0.069.0052.6		FIN085RS00		0.066.1120.0/30	
103,5		0.069.0061.6	FIN214PC10		0.069.0053.6		FIN085RS05		0.066.1120.0/30	
104		0.069.0062.6			0.069.0052.6		FIN085RS10			

		Nr.						ADATTABILE A: SUITABLE FOR:	
---	---	------------	---	---	---	---	---	--------------------------------	---

CR	RP	6	63,50	67,22	29,00		STD - 025 - 050 075 - 100	0.065.1225.0 + 0.065.1225.0	FIN478CR STD
----	----	---	-------	-------	-------	--	------------------------------	--------------------------------	--------------

MB	RP	7	70,00	74,02	26,25		STD - 025 - 050 075 - 100	0.065.1215.0 + 0.065.1216.0	FIN279MB STD
----	----	---	-------	-------	-------	--	------------------------------	--------------------------------	--------------





--	--	--	--	--	--	--	--	--	--



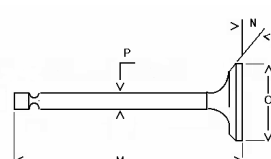

--	--	--	--	--	--	--	--	--	--

PB	BM	6	32,00	36,02	34,00		SEMIF.	0.065.1227.0	FIN5530PB
----	----	---	-------	-------	-------	--	--------	--------------	-----------

TWS	AL	2	82,25	100,00	2,36		STD - 010 - 020	0.065.1218.0 + 0.065.1218.0	FIN167TWS STD
-----	----	---	-------	--------	------	--	-----------------	--------------------------------	---------------

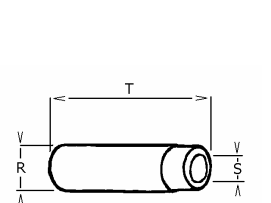
--	--	--	--	--	--	--	--	--	--

	IN		Nr.	O	P	M	N		ADATTABILE A: SUITABLE FOR:								
	IN								FSN	6	44	9	131	30°	A1	0.010.6016.0	FINA6040
	EX								FSN	6	39,5	9	130,5	45°	A1	0.066.1421.0	FINS786

	IN		Nr.	R	S	T		ADATTABILE A: SUITABLE FOR:							
	IN							G	6	15,03	9,02	60	I	0.007.1779.0/10	FIN6519ASA
	EX							G	6	15,03	9,02	60	I	0.007.1779.0/10	FIN6519ASA
	EX														

Ricambi non originali per motori. Denominazioni e codici originali, sono riportati a puro titolo di riferimento.





5 - 65





rel. 905



Non original engine parts. OEMs names and part numbers are for reference purpose only.







SAME







916.6 W1 916.6 W2	Cm³	CILINDRI CYLINDERS	ALESAGGIO BORE	CORSA STROKE	VERSIONE VERSION
	5500	6	103	110	100HP : 3529 → 110HP : 1464 →

		 1,3 mm	
See pos. 1	See pos. 2	0.078.1451.0/40	
Vedere pos. 1	Vedere pos. 2	FIN6268HG	

		 IN	 EX
	0.009.3877.0/10		
	FIN3211CB		

Nr.	ENGINE KIT	
1		FIN1965SL00
1		FIN214PC00
		
		FIN2063KIT

 LV	 LD					
2.1529.073.0	2.1529.072.0				0.044.1567.0	2.4319.130.1
FIN2888RT	FIN2889RT				FIN8225OF	FIN8722FE

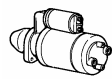
						
2.4519.300.0		2.4619.030.1	2.4729.100.0	2.4619.010.2	2.9439.570.0	2.9619.380.0
FIN919FP		FIN1695E	FIN161NO	FIN1690DV	FIN2382VA	FIN1873TL

1	Serie guarnizione motore con anelli di tenuta, senza guarnizione testa	Gasket set with seal rings, without head gasket	0.075.0050.6	FIN4295SHA
2	Serie guarnizione motore senza anelli di tenuta, senza guarnizione testa	Gasket set without seal rings, without head gasket		FIN4295SHB
3	Guarnizione testa 1,5 mm	Head Gasket 1,5 mm	0.078.1452.0/30	FIN6269HG
4	Guarnizione testa 1,8 mm	Head Gasket 1,8 mm	0.078.1453.0/40	FIN6270HG
5	OR per canna (107,67X1,78)	Liner O ring (107,67X1,78)	2.1519.096.0/10	FIN1096OR
6	Kit revisione pompa alimentazione	Fuel pump repairing kit	2.4519.269.0	FIN2919KFP
7	Cartuccia Filtro Combustibile	Fuel Filter Cartridge	2.4319.220.3	FIN8241FE
8				
9				
10				
11				
12				
13				
14				
15				

Ricambi non originali per motori. Denominazioni e codici originali, sono riportati a puro titolo di riferimento.



6 - 65







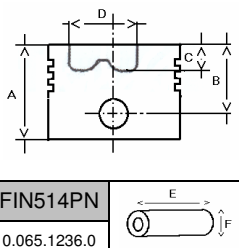

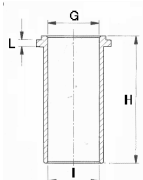
rel. 905

Non original engine parts. OEMs names and part numbers are for reference purpose only.

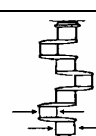
SAME

916.6 W1 916.6 W2	Cm³	CILINDRI CYLINDERS	ALESAGGIO BORE	CORSA STROKE	VERSIONE VERSION
	5500	6	103	110	100HP : 3643 → 110HP : 1966 →

		TESTA HEAD H20	A 100 B 60 C 20,6 D 55 E 77 F 32		3 3 9 3 23 4	TIPO TYPE	CB		G 123 H 193 I 115 L 8

		Nr.						ADATTABILE A: SUITABLE FOR:	
---	---	------------	---	---	---	---	---	--------------------------------	---

CR	RP	6	63,50	67,22	29,00		STD - 025 - 050 075 - 100	0.065.1225.0 + 0.065.1225.0	FIN478CR STD
----	----	---	-------	-------	-------	--	------------------------------	--------------------------------	--------------

MB	RP	7	70,00	74,02	26,25		STD - 025 - 050 075 - 100	0.065.1215.0 + 0.065.1216.0	FIN279MB STD
----	----	---	-------	-------	-------	--	------------------------------	--------------------------------	--------------





--	--	--	--	--	--	--	--	--	--



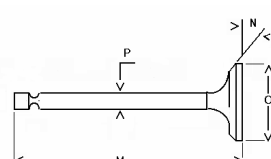

--	--	--	--	--	--	--	--	--	--

PB	BM	6	32,00	36,02	34,00		SEMIF.	0.065.1227.0	FIN5530PB
----	----	---	-------	-------	-------	--	--------	--------------	-----------

TWS	AL	2	82,25	100,00	2,36		STD - 010 - 020	0.065.1218.0 + 0.065.1218.0	FIN167TWS STD
-----	----	---	-------	--------	------	--	-----------------	--------------------------------	---------------

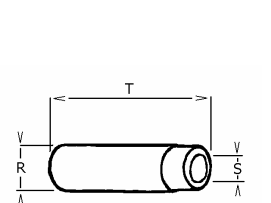
--	--	--	--	--	--	--	--	--	--

	IN EX		Nr.	O	P	M	N		ADATTABILE A: SUITABLE FOR:								
	IN								FSN	6	44	9	131	30°	A1	0.010.6016.0	FINA6040
	EX								FSN	6	39,5	9	130,5	45°	A1	0.066.1421.0	FINS786

	IN EX		Nr.	R	S	T		ADATTABILE A: SUITABLE FOR:							
	IN							G	6	15,03	9,02	60	I	0.007.1779.0/10	FIN6519ASA
	EX							G	6	15,03	9,02	60	I	0.007.1779.0/10	FIN6519ASA
	EX														

Ricambi non originali per motori. Denominazioni e codici originali, sono riportati a puro titolo di riferimento.





7 - 65





rel. 905



Non original engine parts. OEMs names and part numbers are for reference purpose only.







SAME







916.6 W1 916.6 W2	Cm³	CILINDRI CYLINDERS	ALESAGGIO BORE	CORSA STROKE	VERSIONE VERSION
	5500	6	103	110	100HP : 3643 → 110HP : 1966 →

		 1,3 mm	
See pos. 1	See pos. 2	0.078.1451.0/40	
Vedere pos. 1	Vedere pos. 2	FIN6268HG	

		 IN	 EX
	0.009.3877.0/10		
	FIN3211CB		

Nr.	ENGINE KIT	
1		FIN1967SL00
1		FIN214PC00
		
		FIN2064KIT

 LV	 LD					
2.1529.073.0	2.1529.072.0				0.044.1567.0	2.4319.130.1
FIN2888RT	FIN2889RT				FIN8225OF	FIN8722FE

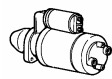
						
2.4519.300.0		2.4619.030.1	2.4729.100.0	2.4619.010.2	2.9439.570.0	2.9619.380.0
FIN919FP		FIN1695E	FIN161NO	FIN1690DV	FIN2382VA	FIN1873TL

1	Serie guarnizione motore con anelli di tenuta, senza guarnizione testa	Gasket set with seal rings, without head gasket	0.075.0050.6	FIN4295SHA
2	Serie guarnizione motore senza anelli di tenuta, senza guarnizione testa	Gasket set without seal rings, without head gasket		FIN4295SHB
3	Guarnizione testa 1,5 mm	Head Gasket 1,5 mm	0.078.1452.0/30	FIN6269HG
4	Guarnizione testa 1,8 mm	Head Gasket 1,8 mm	0.078.1453.0/40	FIN6270HG
5	OR per canna	Liner O ring	2.1539.193.0	FIN1099OR
6	Kit revisione pompa alimentazione	Fuel pump repairing kit	2.4519.269.0	FIN2919KFP
7	Cartuccia Filtro Combustibile	Fuel Filter Cartridge	2.4319.220.3	FIN8241FE
8				
9				
10				
11				
12				
13				
14				
15				

Ricambi non originali per motori. Denominazioni e codici originali, sono riportati a puro titolo di riferimento.



8 - 65







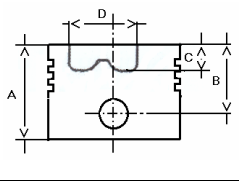

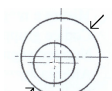
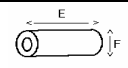
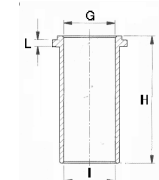
rel. 905

Non original engine parts. OEMs names and part numbers are for reference purpose only.

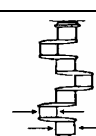
SAME

916.6 WT	Cm³	CILINDRI CYLINDERS	ALESAGGIO BORE	CORSA STROKE	VERSIONE VERSION
	5500	6	103	110	130HP : 1764 ←

		TESTA HEAD	H20		3	3	TIPO TYPE	CB	
					9	3			
	FIN419PN 0.078.1236.0/10		A	100	0.078.0052.6	FIN2324RS00		G	123
			B	60,5				0.066.1120.0/20	H
			C	22,1			I		114
			D	55			L	8	
			E	86			FIN044SL00		
			F	35					

		Nr.						ADATTABILE A: SUITABLE FOR:	
---	---	------------	---	---	---	---	---	--------------------------------	---

CR	RP	6	63,50	67,22	29,00		STD - 025 - 050 075 - 100	0.065.1225.0 + 0.065.1225.0	FIN478CR STD
----	----	---	-------	-------	-------	--	------------------------------	--------------------------------	--------------

MB	RP	7	70,00	74,02	26,25		STD - 025 - 050 075 - 100	0.065.1215.0 + 0.065.1216.0	FIN279MB STD
----	----	---	-------	-------	-------	--	------------------------------	--------------------------------	--------------





--	--	--	--	--	--	--	--	--	--



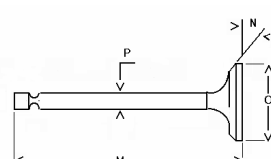

--	--	--	--	--	--	--	--	--	--

PB	BM	6	35,00	39,02	34,65		SEMIF.	2.1559.114.0/10	FIN110PB
----	----	---	-------	-------	-------	--	--------	-----------------	----------

TWS	AL	2	82,25	100,00	2,36		STD - 010 - 020	0.065.1218.0 + 0.065.1218.0	FIN167TWS STD
-----	----	---	-------	--------	------	--	-----------------	--------------------------------	---------------

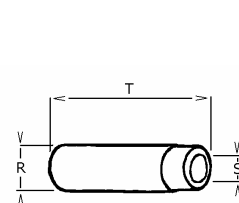
--	--	--	--	--	--	--	--	--	--

		Nr.	O	P	M	N		ADATTABILE A: SUITABLE FOR:									
								IN	FSN	6	44,2	9	130	30°	A1	0.081.1420.0	FINA203
								EX	FSN	6	39,5	9	130,5	45°	A1	0.066.1421.0	FINS786

		Nr.	R	S	T		ADATTABILE A: SUITABLE FOR:								
							IN	G	6	15,03	9,02	60	I	0.007.1779.0/10	FIN6519ASA
							IN								
							EX	G	6	15,03	9,02	60	I	0.007.1779.0/10	FIN6519ASA
EX															

Ricambi non originali per motori. Denominazioni e codici originali, sono riportati a puro titolo di riferimento.





9 - 65





rel. 905



Non original engine parts. OEMs names and part numbers are for reference purpose only.







SAME







916.6 WT	Cm³	CILINDRI CYLINDERS	ALESAGGIO BORE	CORSA STROKE	VERSIONE VERSION
	5500	6	103	110	130HP : 1764 ←

		 1,3 mm	
See pos. 1	See pos. 2	0.078.1451.0/40	
Vedere pos. 1	Vedere pos. 2	FIN6268HG	

		 IN	 EX
	0.009.3877.0/10		
	FIN3211CB		

Nr.	ENGINE KIT	
1		FIN044SL00
1		FIN215PC00
		
	0.078.0065.6	FIN2065KIT

 LV	 LD					
2.1529.073.0	2.1529.072.0				2.4419.340.0	2.4319.130.1
FIN2888RT	FIN2889RT				FIN8230OF	FIN8722FE

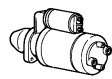
						
2.4519.300.0		2.4619.030.1	2.4729.100.0	2.4619.010.2	2.9439.570.0	2.9619.380.0
FIN919FP		FIN1695E	FIN161NO	FIN1690DV	FIN2382VA	FIN1873TL

1	Serie guarnizione motore con anelli di tenuta, senza guarnizione testa	Gasket set with seal rings, without head gasket	0.078.0050.6	FIN7508SHA
2	Serie guarnizione motore senza anelli di tenuta, senza guarnizione testa	Gasket set without seal rings, without head gasket		FIN7508SHB
3	Guarnizione testa 1,5 mm	Head Gasket 1,5 mm	0.078.1452.0/30	FIN6269HG
4	Guarnizione testa 1,8 mm	Head Gasket 1,8 mm	0.078.1453.0/40	FIN6270HG
5	OR per canna (107,67X1,78)	Liner O ring (107,67X1,78)	2.1519.096.0/10	FIN1096OR
6	Kit revisione pompa alimentazione	Fuel pump repairing kit	2.4519.269.0	FIN2919KFP
7	Cartuccia Filtro Combustibile	Fuel Filter Cartridge	2.4319.220.3	FIN8241FE
8				
9				
10				
11				
12				
13				
14				
15				

Ricambi non originali per motori. Denominazioni e codici originali, sono riportati a puro titolo di riferimento.



10 - 65





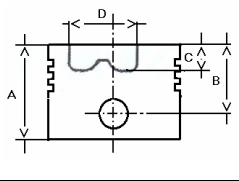

rel. 905

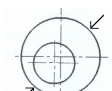
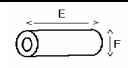
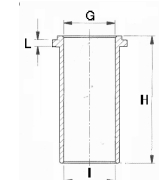
Non original engine parts. OEMs names and part numbers are for reference purpose only.

SAME

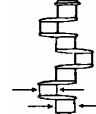
916.6 WT	Cm³	CILINDRI CYLINDERS	ALESAGGIO BORE	CORSA STROKE	VERSIONE VERSION
	5500	6	103	110	130HP : 1765→1802

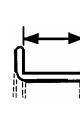
		TESTA HEAD	H20		3	3	TIPO TYPE	CB	
					9	3			
	FIN419PN 0.078.1236.0/10		A	100	0.078.0052.6	FIN2324RS00		G	123
			B	60,5				0.066.1120.0/30	H
			C	22,1			I		114
			D	55			L	8	
			E	86			FIN1965SL00		
			F	35					

		Nr.						ADATTABILE A: SUITABLE FOR:	
---	---	------------	---	---	---	---	---	--------------------------------	---

CR	RP	6	63,50	67,22	29,00		STD - 025 - 050 075 - 100	0.065.1225.0 + 0.065.1225.0	FIN478CR STD
----	----	---	-------	-------	-------	--	------------------------------	--------------------------------	--------------

MB	RP	7	70,00	74,02	26,25		STD - 025 - 050 075 - 100	0.065.1215.0 + 0.065.1216.0	FIN279MB STD
----	----	---	-------	-------	-------	--	------------------------------	--------------------------------	--------------





--	--	--	--	--	--	--	--	--	--



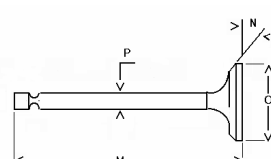

--	--	--	--	--	--	--	--	--	--

PB	BM	6	35,00	39,02	34,65		SEMIF.	2.1559.114.0/10	FIN110PB
----	----	---	-------	-------	-------	--	--------	-----------------	----------

TWS	AL	2	82,25	100,00	2,36		STD - 010 - 020	0.065.1218.0 + 0.065.1218.0	FIN167TWS STD
-----	----	---	-------	--------	------	--	-----------------	--------------------------------	---------------

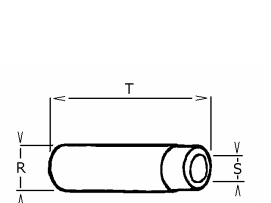
--	--	--	--	--	--	--	--	--	--

	IN EX		Nr.	O	P	M	N		ADATTABILE A: SUITABLE FOR:									
									IN	FSN	6	44,2	9	130	30°	A1	0.081.1420.0	FINA203
									EX	FSN	6	39,5	9	130,5	45°	A1	0.066.1421.0	FINS786

	IN EX		Nr.	R	S	T		ADATTABILE A: SUITABLE FOR:								
								IN	G	6	15,03	9,02	60	I	0.007.1779.0/10	FIN6519ASA
								IN								
								EX	G	6	15,03	9,02	60	I	0.007.1779.0/10	FIN6519ASA
EX																

Ricambi non originali per motori. Denominazioni e codici originali, sono riportati a puro titolo di riferimento.





11 - 65





rel. 905



Non original engine parts. OEMs names and part numbers are for reference purpose only.







SAME







916.6 WT	Cm³	CILINDRI CYLINDERS	ALESAGGIO BORE	CORSA STROKE	VERSIONE VERSION
	5500	6	103	110	130HP: 1765→1802

		 1,3 mm	
See pos. 1	See pos. 2	0.078.1451.0/40	
Vedere pos. 1	Vedere pos. 2	FIN6268HG	

		 IN	 EX
	0.009.3877.0/10		
	FIN3211CB		

Nr.	ENGINE KIT	
1		FIN1965SL00
1		FIN215PC00
		
	0.078.0065.6/10	FIN2066KIT

 LV	 LD					
2.1529.073.0	2.1529.072.0				2.4419.340.0	2.4319.130.1
FIN2888RT	FIN2889RT				FIN8230OF	FIN8722FE

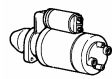
						
2.4519.300.0		2.4619.030.1	2.4729.100.0	2.4619.010.2	2.9439.570.0	2.9619.380.0
FIN919FP		FIN1695E	FIN161NO	FIN1690DV	FIN2382VA	FIN1873TL

1	Serie guarnizione motore con anelli di tenuta, senza guarnizione testa	Gasket set with seal rings, without head gasket	0.078.0050.6	FIN7508SHA
2	Serie guarnizione motore senza anelli di tenuta, senza guarnizione testa	Gasket set without seal rings, without head gasket		FIN7508SHB
3	Guarnizione testa 1,5 mm	Head Gasket 1,5 mm	0.078.1452.0/30	FIN6269HG
4	Guarnizione testa 1,8 mm	Head Gasket 1,8 mm	0.078.1453.0/40	FIN6270HG
5	OR per canna (107,67X1,78)	Liner O ring (107,67X1,78)	2.1519.096.0/10	FIN1096OR
6	Kit revisione pompa alimentazione	Fuel pump repairing kit	2.4519.269.0	FIN2919KFP
7	Cartuccia Filtro Combustibile	Fuel Filter Cartridge	2.4319.220.3	FIN8241FE
8				
9				
10				
11				
12				
13				
14				
15				

Ricambi non originali per motori. Denominazioni e codici originali, sono riportati a puro titolo di riferimento.



12 - 65







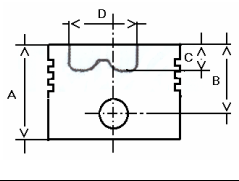

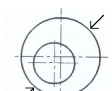
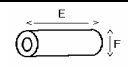
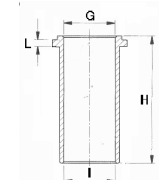
rel. 905

Non original engine parts. OEMs names and part numbers are for reference purpose only.

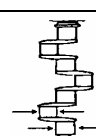
SAME

916.6 WT	Cm³	CILINDRI CYLINDERS	ALESAGGIO BORE	CORSA STROKE	VERSIONE VERSION
	5500	6	103	110	130HP : 1803 →

		TESTA HEAD	H20		3	3	TIPO TYPE	CB	
					9	3			
	FIN419PN 0.078.1236.0/10		A	100	0.069.0052.6	FIN085RS00		G	123
			B	60,5				0.066.1120.0/60	H
			C	22,1			I		115
			D	55			L	8	
			E	86			FIN1967SL00		
			F	35					

		Nr.						ADATTABILE A: SUITABLE FOR:	
---	---	------------	---	---	---	---	---	--------------------------------	---

CR	RP	6	63,50	67,22	29,00		STD - 025 - 050 075 - 100	0.065.1225.0 + 0.065.1225.0	FIN478CR STD
----	----	---	-------	-------	-------	--	------------------------------	--------------------------------	--------------

MB	RP	7	70,00	74,02	26,25		STD - 025 - 050 075 - 100	0.065.1215.0 + 0.065.1216.0	FIN279MB STD
----	----	---	-------	-------	-------	--	------------------------------	--------------------------------	--------------





--	--	--	--	--	--	--	--	--	--



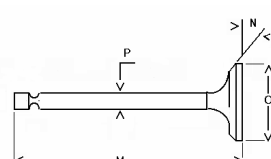

--	--	--	--	--	--	--	--	--	--

PB	BM	6	35,00	39,02	34,65		SEMIF.	2.1559.114.0/10	FIN110PB
----	----	---	-------	-------	-------	--	--------	-----------------	----------

TWS	AL	2	82,25	100,00	2,36		STD - 010 - 020	0.065.1218.0 + 0.065.1218.0	FIN167TWS STD
-----	----	---	-------	--------	------	--	-----------------	--------------------------------	---------------

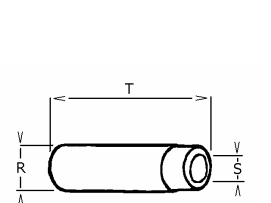
--	--	--	--	--	--	--	--	--	--

	IN EX		Nr.	O	P	M	N		ADATTABILE A: SUITABLE FOR:									
									IN	FSN	6	44,2	9	130	30°	A1	0.081.1420.0	FINA203
									EX	FSN	6	39,5	9	130,5	45°	A1	0.066.1421.0	FINS786

	IN EX		Nr.	R	S	T		ADATTABILE A: SUITABLE FOR:								
								IN	G	6	15,03	9,02	60	I	0.007.1779.0/10	FIN6519ASA
								IN								
								EX	G	6	15,03	9,02	60	I	0.007.1779.0/10	FIN6519ASA
EX																

Ricambi non originali per motori. Denominazioni e codici originali, sono riportati a puro titolo di riferimento.





13 - 65





rel. 905



Non original engine parts. OEMs names and part numbers are for reference purpose only.







SAME







916.6 WT	Cm³	CILINDRI CYLINDERS	ALESAGGIO BORE	CORSA STROKE	VERSIONE VERSION
	5500	6	103	110	130HP : 1803 →

		 1,3 mm	
See pos. 1	See pos. 2	0.078.1451.0/40	
Vedere pos. 1	Vedere pos. 2	FIN6268HG	

		 IN	 EX
	0.009.3877.0/10		
	FIN3211CB		

Nr.	ENGINE KIT	
1		FIN1967SL00
1		FIN215PC00
		
	0.078.0065.6/20	FIN2067KIT

 LV	 LD					
2.1529.073.0	2.1529.072.0				2.4419.340.0	2.4319.130.1
FIN2888RT	FIN2889RT				FIN8230OF	FIN8722FE

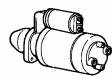
						
2.4519.300.0		2.4619.030.1	2.4729.100.0	2.4619.010.2	2.9439.570.0	2.9619.380.0
FIN919FP		FIN1695E	FIN161NO	FIN1690DV	FIN2382VA	FIN1873TL

1	Serie guarnizione motore con anelli di tenuta, senza guarnizione testa	Gasket set with seal rings, without head gasket	0.078.0050.6	FIN7508SHA
2	Serie guarnizione motore senza anelli di tenuta, senza guarnizione testa	Gasket set without seal rings, without head gasket		FIN7508SHB
3	Guarnizione testa 1,5 mm	Head Gasket 1,5 mm	0.078.1452.0/30	FIN6269HG
4	Guarnizione testa 1,8 mm	Head Gasket 1,8 mm	0.078.1453.0/40	FIN6270HG
5	OR per canna	Liner O ring	2.1539.193.0	FIN1099OR
6	Kit revisione pompa alimentazione	Fuel pump repairing kit	2.4519.269.0	FIN2919KFP
7	Cartuccia Filtro Combustibile	Fuel Filter Cartridge	2.4319.220.3	FIN8241FE
8				
9				
10				
11				
12				
13				
14				
15				

Ricambi non originali per motori. Denominazioni e codici originali, sono riportati a puro titolo di riferimento.

14 - 65

rel. 905

Non original engine parts. OEMs names and part numbers are for reference purpose only.

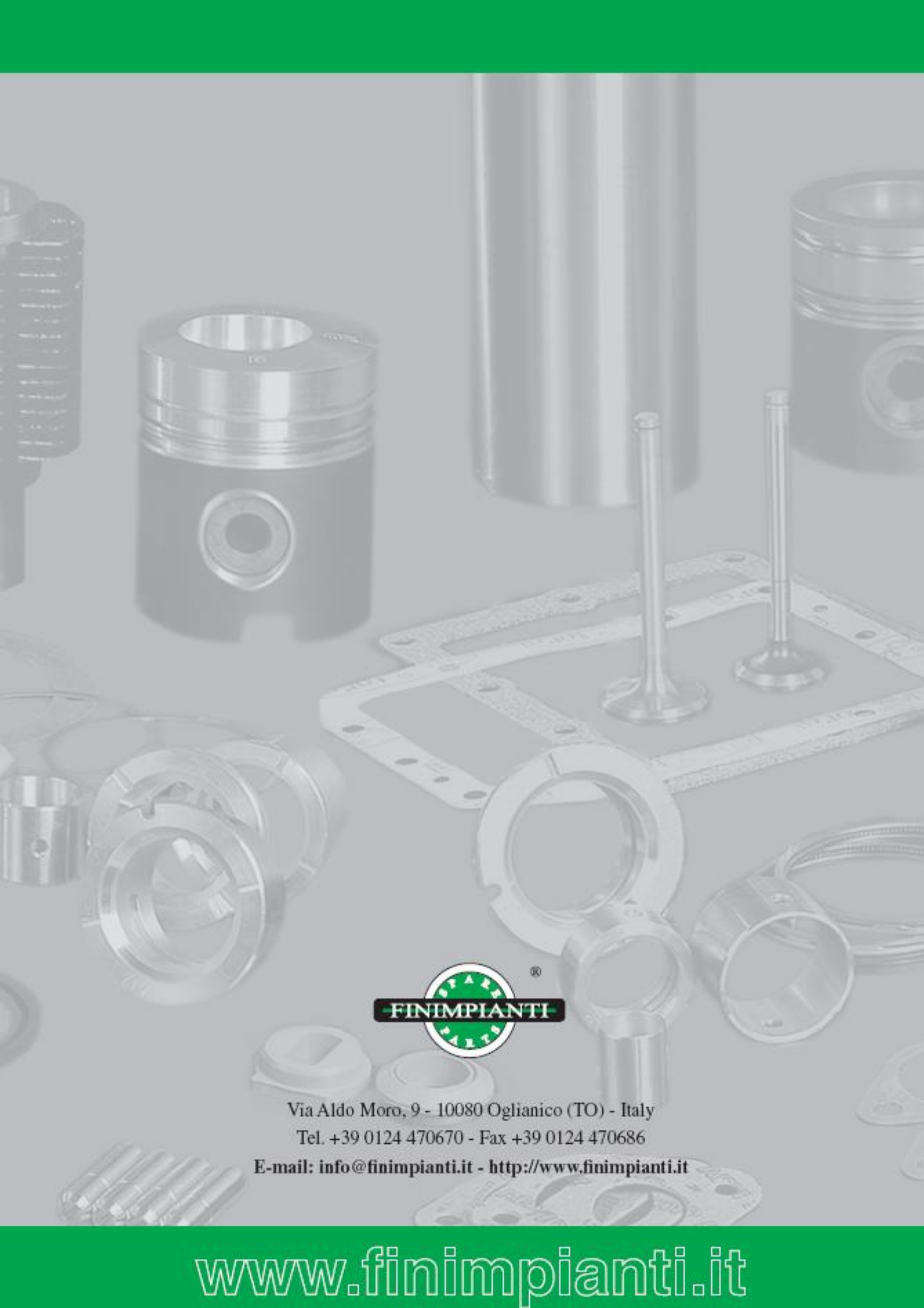

Via Aldo Moro, 9 - 10080 Oglianico (TO) - Italy

Tel. +39 0124 470670 - Fax +39 0124 470686

E-mail: info@finimpianti.it - <http://www.finimpianti.it>

www.finimpianti.it